

AI2009-4

**AIRCRAFT SERIOUS INCIDENT
INVESTIGATION REPORT**

**JAPAN AIRLINES INTERNATIONAL CO., LTD.
J A 8 9 8 6**

May 29, 2009

Japan Transport Safety Board

The investigation for this report was conducted by Japan Transport Safety Board, JTSB, about the aircraft serious incident of JAPAN AIRLINES INTERNATIONAL , B767-300 registration JA8986 in accordance with the act for Establishment of the Japan Transport Safety Board and Annex 13 to the Convention on International Civil Aviation for the purpose of determining causes of the aircraft serious incident and contributing to the prevention of accidents/incidents and not for the purpose of blaming responsibility of the serious incident.

This English version of this report has been published and translated by JTSB to make its reading easier for English speaking people who are not familiar with Japanese. Although efforts are made to translate as accurately as possible, only the Japanese version is authentic. If there is any difference in the meaning of the texts between the Japanese and English versions, the text in the Japanese version prevails.

Norihiro Goto,
Chairman,
Japan Transport Safety Board

AIRCRAFT SERIOUS INCIDENT INVESTIGATION REPORT

JAPAN AIRLINES INTERNATIONAL CO., LTD.

BOEING 767-300, JA8986

AT ABOUT 9:59 JST, JUNE 15, 2005

ON RUNWAY 34L OF TOKYO INTERNATIONAL AIRPORT

April 24, 2009

Adopted by the Japan Transport Safety Board
(Aircraft Sub-committee)

Chairman	Norihiro Goto
Member	Yukio Kusuki
Member	Shinsuke Endo
Member	Noboru Toyooka
Member	Yuki Shuto
Member	Akiko Matsuo

1. PROCESS AND PROGRESS OF THE SERIOUS INCIDENT

INVESTIGATION

1.1 Summary of the Serious Incident

This occurrence covered by this report falls under the category of Clause 14, Article 166-4 of the Civil Aeronautics Regulations of Japan (at the time of the occurrence), as the case equivalent to “Overrunning, Undershooting, or Running off the runway (limited to the case that the aircraft is unable to taxi by itself)” as stipulated in Clause 3 of same Article (at the time of the occurrence), and is classified as an aircraft serious incident.

On June 15 (Wednesday), 2005, a Boeing 767-300, registered JA8986, operated by Japan Airlines International Co., Ltd., lapsed into the condition not able to taxi by itself on the runway due to nose gear damage at about 9:59 Japan Standard Time (JST) (unless otherwise indicated, all times are JST, UTC+9h), when it landed on Runway 34L at Tokyo International Airport as the company's scheduled flight 1002.

There were 222 persons on board in total, consisting of the captain, 11 other crewmembers, and 210 passengers. 17 passengers sustained minor injuries.

The aircraft was slightly damaged, but there was no fire.

1.2 Outline of the Serious Incident Investigation

1.2.1 Investigation Organization

(1) On June 15, 2005, the Aircraft and Railway Accidents Investigation Commission assigned an investigator-in-charge and three other investigators with responsibility to investigate this serious incident.

In addition, on October 18, 2005, another investigator was assigned.

(2) Three expert advisers were appointed for the investigation of the following technical matters with respect to this serious incident investigation.

① Investigation of airframe movement

Helicopter Flight Safety Team (at the time of appointment)

Air Safety Technology Center

Institute of Space Technology and Aeronautics

Japan Aerospace Exploration Agency

Naoki MATAYOSHI
(Appointed on July 12, 2005)

② Investigation of airframe structure

Structure Research Group Chief (at that time of appointment)

Institute of Space Technology and Aeronautics

Japan Aerospace Exploration Agency

Ipeei SUSUKI
(Appointed on August 1, 2005)

Airframe Strength Team (at that time of appointment)

Air Safety Technology Center

Institute of Space Technology and Aeronautics

1.2.2 Representatives from Foreign Authorities

An accredited representative of the United States of America, the State of Design and Manufacture of the aircraft involved in this serious incident, participated in the investigation.

1.2.3 Implementation of Investigation

June 15 and 16, 2005	Airframe inspection, interviews and runway inspection
June 17 to 19, 2005	Inspection of collected fragments, the airframe and the left engine
June 21 to 23, 2005	Nose gear teardown inspection
June 24, 2005	Inspection of the wheels and the inside of the engine
June to November, 2005	Inspection of the tires
July 4, 2005	Inspection of the wheels and collected fragments
July 7 to September 12, 2005	Inspection of the airframe and wheels
July 15 and 29, 2005	Runway inspection and fragment collection
August 25, 2005	Inspection of airframe parts
September 5 to October 19, 2005, and January 19, 2006	Inspection of the wheels and airframe parts
September 28, 2005	Interviews
October 17, 2005	Inspection of the wheels
November 2005 to January 2006	Strength tests of the wheels and tires
January 18 and March 14, 2006	Investigation using the full flight simulator
February to June, 2006	Inspection of the wheels and tires
January 16, 18, February 2, May 15, 22, and 29, 2007	Research on the Boeing 767-300 movement during landings
March to October, 2007	Inspection of the tires

1.2.4 Interim Report

On May 26, 2006, the interim report based on the result of the fact-finding investigation up to that date was submitted to the Minister of the Land, Infrastructure and Transport, and made public.

1.2.5 Comments from Parties relevant to the Cause of the Serious Incident

Comments were taken from parties relevant to the cause of the serious incident.

1.2.6 Comments from the Participating State

Comments were invited from the participating state.

2. FACTUAL INFORMATION

2.1 History of the Flight

On June 15, 2005, a Boeing 767-300, registered JA8986 (hereinafter referred to as “the Aircraft”), operated by Japan Airlines International Co., Ltd. (hereinafter referred to as “the Company”), took off from New Chitose Airport bound for Tokyo International Airport on scheduled flight 1002.

The flight plan submitted to the Fukuoka Area Control Center of the Ministry of Land, Infrastructure and Transport was as outlined below:

Flight rules: Instrument flight rules (IFR)

Departure aerodrome: New Chitose Airport

Estimated off-block time: 08:30

Cruising speed: 478 kt

Cruising altitude: FL350

Route: TOBBY (reporting point) – Y10 (airway) – TLE (Ami VOR/DME),

Destination aerodrome: Tokyo International Airport

Total estimated elapsed time: 1 hour and 14 minutes

Fuel on board in terms of endurance: 4 hours and 12 minutes

There were 222 people on board the Aircraft, consisting of the captain, 11 other crewmembers and 210 passengers. In the cockpit, the first officer was in the left seat as PF (Pilot Flying: primarily responsible for aircraft maneuvering duty), the captain was in the right seat as PNF (Pilot Not Flying: primarily responsible for non-maneuvering duty), and another first officer was in the observer’s seat.

According to the records of the digital flight data recorder (hereinafter referred to as “the DFDR”), the records of the cockpit voice recorder (hereinafter referred to as “the CVR”) and the air traffic control (hereinafter referred to as “ATC”) communications records, as well as the statements from the flight crewmembers, the cabin attendants and the passengers, the flight history of the Aircraft after it prepared to land on the final approach course to Runway 34L of Tokyo International Airport is as outlined below.

2.1.1 Flight History based on DFDR, CVR, and ATC Communications Records

The Aircraft made its initial contact with Tokyo Airport Traffic Control Tower (hereinafter referred to as “the Tower”) at 09h55m45s (hereinafter the indication of the hour is omitted). The Tower notified the Aircraft of landing sequence as No.3, runway in use as Runway 34L, and wind information as “030 degrees (direction) at 15 kt (velocity)”, and then instructed the Aircraft to continue approach.

56m03s The PF requested the PNF to implement the landing check.

57m09s The PF said, “I’ll set the speed by +8 kt,” and the PNF responded “142.”

58m12s The Tower cleared the Aircraft to land on Runway 34L, and the PNF acknowledged.

58m32s The PNF made a “five hundred” call, and the PF answered as “Stabilized.”

The Aircraft was flying at a height indicated by the radio altimeter (hereinafter referred to as “a height”) of 512 ft, with a nose heading (hereinafter referred to as “a

heading”) of 340°, a pitch angle of 1.8°, computed airspeed (CAS) of 142 kt, and inertial vertical velocity (IVV) of -784 ft/min.

58m39s The PNF called “Approaching minimum”, and the PF responded “Check.”

The Aircraft was flying at a height of 432 ft, with a heading of 341.7°, a pitch angle of 2.1°, a CAS of 143 kt, and a IVV of -624 ft/min.

58m49s The PNF called “Minimum” and the PF responded “Landing.”

The Aircraft was flying at a height of 315 ft, with a heading 342.4°, a pitch angle of 1.4°, a CAS of 141 kt, and a IVV of -704 ft/min.

From around this time on, the control column started to move back and forth and the control wheel started to move laterally significantly, which further caused the roll angle to change markedly, and the pitch angle started to vary cyclically in four to six seconds intervals.

58m53s The PNF advised the PF to “just keep this heading.” The PF responded “Yes.”

The Aircraft was flying at a height of 271 ft, with a heading of 340.3°, a pitch angle of 0.7°, a CAS of 143 kt and a IVV of -736 ft/min.

59m05s A voice callout¹ of “One hundred” was announced.

The Aircraft was flying at a height of 108 ft, with a heading of 337.1°, a pitch angle of 1.4°, a CAS of 146 kt, and a IVV of -720 ft/min.

59m08s The Aircraft was flying at a height of 72 ft, with a heading of 336.4°, the pitch angle in the range between 2.8 and 3.2°, a CAS of 137 kt and a IVV of -672 ft/min. The control column position (CCP) changed from -1.05° to + 1.05°.

59m09s A voice callout of “Fifty” was announced.

The Aircraft was flying at a height of 59 ft, with a heading of 336.8°, a pitch angle of 2.8°, the CCP changing from -1.41° to -2.11°, a CAS of 139 kt, and a IVV of -672 ft/min.

59m10s A voice callout of “Thirty” was announced.

The Aircraft was flying at a height of 32 ft, with a heading of 337.1°, the pitch angle decreasing from 2.5° to 1.8°, 1.4°, and to 1.1°, the CCP changing from 0.35° to -1.05°, a CAS of 140kt, and a IVV of -736 ft/min.

59m11s A voice callout of “Twenty” was announced.

59m12s A voice callout of “Ten” was announced.

59m13s The clattering sound of the lock solenoid² in the gear operation lever module was being recorded.

In the latter half of 59m13s, the air/ground sensor indicated GROUND , and remained in this state until the Aircraft came to a stop.

The table below shows the detailed changes, between 09h59m11s and 09h59m17s, of pitch angle, vertical acceleration, longitudinal acceleration, CCP, etc., including their movements that occurred during intervals of less than one second. Note that the number of recording times per second for each parameter is the same as the number of times given in the table.

¹ A callout is announced in a synthetic voice in order to draw the attention of pilots.

² An electromagnetic excitation instrument which activates the mechanism required to limit the lever movement of the gear operation lever module and prevent the gear-down lever from being inadvertently set to the gear-up position when aircraft are on the ground.

Time 09h	Radio Altitude (ft) AIR/GND	CAS(kt) Ground Speed (kt)	Heading (°) IVV (ft/min)	Pitch Angle (°)	Vertical Acceleration (G)	Longitudinal Acceleration (G)	CCP (°) (Control column Back and forth Position)	Thrust Reverser	Speed Brake %	Brake(PSI) LEFT. RIGHT
59:11	22,AIR	140 136	337.9	0.7	0.954	0.027	2.46	STOW	15.8	0-0
	AIR			0.7	0.959					
	AIR			0.7	0.913	0.037				
	AIR			0.7	0.918					
59:12	11,AIR	142 136	337.5	1.8	0.913	0.067	2.81	STOW	15.8	0-0
	AIR			1.8	0.993					
	AIR			2.8	1.069	0.080				
	AIR			3.2	1.073					
59:13	4,AIR	139 136	337.5	3.5	1.087	0.084	3.87	STOW	15.8	0-0
	AIR			3.5	1.108					
	AIR			3.9	1.126	0.098				
	GND			4.2	1.142					
59:14	-3,GND	139 136	337.1	4.6	1.188	0.084	2.81	STOW	15.8	0-0
	GND			4.9	1.174					
	GND			4.6	1.124	0.031				
	GND			3.5	1.050					
59:15	-2,GND	139 136	336.8	2.5	1.011	-0.071	-1.41	STOW	99.1	0-0
	GND			1.4	1.009					
	GND			-0.7	1.066	-0.142				
	GND			-0.4	1.101					
59:16	-5,GND	142 132	336.1	1.1	1.147	-0.014	-8.79	TRAN	99	320-256
	GND			1.1	1.098					
	GND			1.4	1.478	-0.047				
	GND			0	1.359					
59:17	-5,GND	133 132	336.4	-1.1	1.492	-0.254	-7.73	RVRS	99	256-128
	GND			-1.4	0.382					
	GND			-1.1	0.258	-0.265				
	GND			-1.1	0.288					

(***) : Values exceed the measurable range.

59m15s A very loud breaking sound was recorded, and then noises that sounded as if the Aircraft was running on the metal parts of the wheels were continuously being recorded, albeit with tonal differences.

Immediately after the vertical acceleration hit its largest value of 3.422G, the

IVV recorded +672 ft/min.

59m19s Noises that sounded like a hard metallic wheel rolling were continuously recorded from 59m19s to 59m24s.

The Aircraft was at a ground speed of 120 kt with a heading of 337.9°.

59m25s The PF initiated the brake operation.

The Aircraft was at a ground speed of 100 kt with a heading of 336.8°.

59m30s A brattle just as like hitting something started to be heard. Then, the hitting cycle had gradually become long.

The Aircraft was at a ground speed of 84 kt with a heading of 336.1°.

59m31s The PNF called, "Speed brake up."

The Aircraft was at a ground speed of 80 kt with a heading of 336.8°.

59m35s A brattle just as like hitting something stopped.

The Aircraft was at a ground speed of 60 kt with a heading of 336.4°.

59m52s The ground speed of the Aircraft became 0 kt, at which time the Aircraft came to a stop.

2.1.2 Statements of Flight Crewmembers

(1) Captain

This flight was conducted with a view to improve the maneuvering skills of the two first officers who were about to undertake captain training and to have the mutual observation of their maneuvers.

Regarding the nose tires became disengaged this time, I did not feel as though anything was wrong during the take-off roll at New Chitose Airport.

We made a landing briefing at approximately 15 minutes before starting the descent. According to the first ATIS, a northeasterly wind with a crosswind component of about 17 kt was blowing at Tokyo International Airport. We discussed points to pay attention to on the short final, because the wind condition was prone to be disturbed by impact of a hanger when the northeasterly wind blew on Runway 34L of the Airport, especially when an aircraft came down closer to the ground.

At 09:25, thirty minutes before the scheduled arrival time, the PF turned on the seat-belt sign, and initiated the descent. Upon being cleared to descend from 5,000 to 3,000 ft, the PF switched the auto pilot over to manual operation.

Our final approach was in cloud, and I remember it was below 1,000 ft when we finally came out of the clouds.

When we were cleared to land, a wind of 16 kt was blowing from the north-northeast. As I called "500 ft," the PF replied "Stabilized," and when I called "Minimum," the PF responded "Landing." The flight condition was stable enough, but I watched the maneuvering of the PF, placing my foot on the rudder.

The Aircraft began to be bumpy at around a height of 100 ft by impact of the buildings. The PF was cautiously maintaining the power to prevent a hard landing, but I felt the Aircraft sinking slightly from a height of about 30 ft. While holding the pitch so as to prevent a hard landing, the PF was controlling the Aircraft in a manner to keep some engine thrust by not fully retarding the thrust lever to idle.

Both the main tires touched the ground simultaneously somewhat firmly. There had been

no problems with the operation up to that point when the main tires touched the ground, and his maneuvering was acceptable. The nose tends to drop with a thud when the main tires touch the ground in a firm manner, so both the PF and I were holding the control wheel, but the nose touched the ground so much faster than usual that my body floated in mid-air. Immediately after the nose touched the ground, there was a huge rasping noise, and we felt an incredibly strong impact.

Then, when the thrust reverser was applied, we heard an abnormal sound from the left engine. As the PF was able to keep to the centerline, I monitored the instruments in preparation for an engine fire without taking over from him.

The Aircraft stopped short of Taxiway A6. The auto brake had been set to 3. The Aircraft came to a full stop and we confirmed that there was no possibility of a fire. We intended to contact the Tower, but were unable to establish communications for one or two minutes, apparently due to keying of transmitters. After a while, communications were established and the Tower told us that the tires had been disengaged during the landing. We requested a tow truck, but as we were told by a mechanic that towing was impossible, we decided to ask the passengers to disembark from the Aircraft on the runway.

(2) First Officer

I did the pre-departure external inspection of the Aircraft, I checked that there were no abnormalities, and reported to that effect to the captain.

During the pre-flight briefing, I was informed that the area around Tokyo International Airport was overcast due to a seasonal rain front. So I turned on the seatbelt sign at 09:25, 30 minutes before landing, as had been discussed with the cabin crew, and received a report from a CA that all passengers had been seated.

During the descent, we experienced light turbulence now and then in the clouds, and after Ami VOR/DME, we sometimes had strong turbulence, then the control was transferred to the Approach Control of Tokyo International Airport. When we received clearance to descend from 5,000 to 3,000 ft, I turned off the auto pilot and auto throttle.

When we were cleared to land at a height of 1,000 ft, we were still flying in the clouds. Although it was at about 300 ft of the Minimum that we finally confirmed the runway visually, we had been able to recognize the approach lights before then from the window. Taking crosswinds into account, we approached at 142 kt by adding 8 kt to the Vref of 134 kt, with the flap and auto brake set to 25 and 3 respectively.

We landed at 09:59. I felt we made a somewhat firm touchdown. I was holding the control wheel to prevent it moving, but I still felt the nose went down quite faster than usual. It went down very smoothly, although I have only a vague memory around here, and then I experienced an intense impact accompanied by a loud "dong" noise, and I felt my body was pitched forward. Even after the nose touched down, the intense impact continued as well as a strange "rasping" sound and vibration. I applied the thrust reverser as usual with the speed brake positioned up. I thought the deceleration rate was higher than that of normal auto brake 3, although I did not know the actual speed, and I retarded the thrust reverser. I was making the landing roll while being aware that, given the vibration, we might have flat nose tires.

I retarded the thrust reverser and stepped on the brake almost simultaneously. I didn't feel anxious about stopping, but as I was concentrating on keeping the Aircraft moving straight ahead, I didn't check how fast we were going.

I declared that it would be impossible to taxi into A6, and we stopped on the runway. I

think the point from where we could enter A6 was well ahead of us. I think the first touchdown point was between 1,000 and 1,500 ft from the threshold.

Usually, when the northeasterly wind blows at Tokyo International Airport, the hangar causes air turbulence, which I have known for a long time, and in fact turbulence that was considered to be the impact of the hangar did occur from a height of about 100 ft, but it was more or less the same as what we normally experienced, and the wind shear alert did not activate.

After the Aircraft came to a full stop, the PNF tried to contact the Tower, but it was impossible to establish communications for a while. After the communications were reestablished, the PNF reported that we were stopping on the runway, and requested a tow truck. We received a report from the Tower saying that the tires had been disengaged.

Until then, the engine instrument panel had not indicated any abnormalities, so after receiving clearance from the Tower, we started up the APU and then shut down both engines.

(3) First Officer in the observer's seat (the seat in the back of the pedestal between the left and right pilot seats)

At 3,000 ft, we were instructed to make an ILS approach to Runway 34L, and we were approaching at a speed in accordance with the procedure.

The wind up in the air was northeasterly wind, which was roughly the same direction as the wind on the ground, but it was slightly strong, about 30 kt. The flap was set to 25, and as far as I was looking from the observer's seat, I thought that we were making a stable approach.

The crosswind was so strong that the PF set the approach speed to $V_{ref} + 8$ kt, which is 142 kt. The auto brake was set to 3.

It is well known that aircraft are shaken by turbulence caused by impact of the buildings under the northeasterly wind, so I think that the PF was also well aware of it.

When we passed at a height of 1,000 ft, the landing clearance was issued, and we could see the approach lights from around that time. At a height of 500 ft, the PF made the standard callout of "Stabilized." On the short final, we experienced bumpy turbulence at about 100 ft, which seemed to be caused by impact of the buildings. I felt a slightly large sink-in at the time of flare, and the first touchdown was slightly hard. After that, although I did not know how many seconds later it was, we felt tremendous G-force, but I don't clearly remember what kind of movement it was. The movement after touchdown was beyond our imagination.

The landing roll was accompanied with vibration and a loud strange "rasping" noise, which, in hindsight, sounded as if the tires had been disengaged. When I looked around, the contents of my flight bag were scattered ahead, so I thought that a minus G-force was applied then.

After the Aircraft came to a stop, the captain called the Tower, but the captain could not establish contact under the condition of keying on some transmitter. I think it was one or two minutes later that communications were reestablished, and the Tower told us that the tires had fallen off behind the Aircraft.

After the Aircraft stopped, a passenger announcement was made by both the PF and PNF. Instead of getting involved in the announcement myself, I dedicated myself on the advice for stopping the engines and on alert for something which could be deemed abnormal.

2.1.3 Statements of Cabin Attendants

(1) Senior cabin attendant

When the main landing gear first touched down on the runway, I felt that the impact was

stronger than usual.

I felt that the time until the nose gear touched down on the runway was a bit long, and when it actually landed, the impact was much stronger than usual; my bottom was hit hard, and I felt at that moment that the Aircraft landed not on the tires but on metal parts. Then, I sensed a “rasping” vibration as if the Aircraft were running only on axles without tires. The intensity of that impact was such that I could neither hold my seat in order to keep the brace position, nor take look at the cabin.

Due to that impact, passengers' cigarettes and lighters, as well as postcards and time schedule brochures that had jumped out from letter racks, were scattered on the cabin floor.

(2) Cabin attendant

When the main landing gear made a loud bang during the landing, I thought that the landing was a bit harder than usual; but when the nose gear landed on the runway the second time, I had a stronger impact than I had ever felt before; and I felt that what I experienced at that moment was a roll without nose tires. I think that there was probably a third bounce, but the second bounce was so heavy that I didn't remember well.

(3) Deputy senior cabin attendant

I felt a light turbulence during the final approach. At the moment when the Aircraft made a touchdown, there was an unusually strong impact as if we had fallen from a higher position. After that, it felt like we bounced about two or three times, and there was both horizontal and vertical quake, and that situation continued until the landing roll came to a stop.

2.1.4 Statements of Passengers

(1) Passenger A

I was awake before landing and looking ahead. After the main landing gear touched down on the ground, it felt like the airframe bounced, and the second touchdown was fierce. I didn't suffer any injuries to my neck or so on.

(2) Passenger B

The first landing impact was stronger than usual. I felt as if the force of the moment caused the front (the nose gear) to touch the ground. The impact at that time was something I had never experienced before, and it made me float in mid-air and I felt as if my bones were jarring. Then, I felt like we had the left flat tire, and then I felt like the right tire was flat after pounding impact. During the roll, there was a rumbling noise and the impact was also strong.

(3) Passenger C

At an altitude of about 300 meters, the airframe quaked and rattled in small and short motions, and below 100 meters, strong wind caused the airframe to vibrate. After that I think that the airframe quaked and dropped with a thud. I felt like the left main landing gear touched down, and then the right main landing gear and the nose gear touched down with a thud, followed by bouncing up to the right. After that, the nose gear touched down but during the landing roll the Aircraft was jouncing and I wondered if the tires had been ripped off.

2.1.5 Witness (a mechanic who witnessed the landing of the Aircraft, age 44)

I happened to witness the landing of the Aircraft when I was on the ground aft and nearby an aircraft at spot 2, which was waiting for pushing back shortly.

It was not that the nose-up pitch immediately before the landing was small. The main

landing gear touched down almost abeam Taxiway W2, the Aircraft didn't appear to bound, and I did not feel that there has been something abnormal.

I don't remember how long it took from the touchdown of the main landing gear to that of the nose gear. When the nose gear touched down just short of Taxiway W3, the nose pitching was so much larger than usual that I could visibly confirm it from a distance.

The nose sank significantly once, and I could see the nose vibrating in a movement different from usual, and then it repeated pitching twice or so. Rather than having being caused by the movement of the oleo, it seemed that the nose sank with a thud when the nose gear first made the touchdown, and then extended upward and returned to its original position. At that time, I thought something was strange, and wondered if the Aircraft had made a hard landing or if there might have been some other defects.

As the Aircraft taxied around the midpoint between Taxiways W3 and W4, I saw tires rolling near the airframe, and it looked like the airframe passed them. At that point, I couldn't figure out which tires disengaged. The tires seemed to be rolling rather than bouncing.

I think that the thrust reverser was deployed probably at that time; but as it was raining heavily and splashing, I couldn't focus on the Aircraft clearly, and the airframe soon went behind the terminal building.

Since I was quite a distance away, and was also wearing earmuffs, I didn't hear any sound that occurred at that time.

This serious incident occurred at about 09:59, on June 15, 2005, on a runway of Tokyo International Airport (latitude 35°32' 56" north and longitude 139°46' 37" east).

(See Figures 1, 2, 3, 4, 5-1, 5-2, 5-3, and Photographs 1 through 5.)

2.2 Injuries to Persons

Immediately after this serious incident, three passengers claimed to have neck pain and nausea. One of them was examined at the airport clinic, where the person was diagnosed as having suffered a whiplash injury and requiring one week for recovery. Later, 14 people (their seats were in various locations throughout the cabin) claimed they had pain in the neck, back, low back, and so on.

2.3 Damage to the Aircraft

2.3.1 Extent of Damage

Minor damage.

2.3.2 Damage to the Aircraft Parts

Nose gear: Damage to wheels, disengagement of tires, separation of and damage to peripheral accessories

Main landing gear: The front inner tire of the right main landing gear was punctured.

The body and wings: The front skin, the right main wing leading-edge slat, and trailing-edge flaps of both the right and left wings, etc., were damaged.

Left engine: A number of fan blades, low pressure compressor blades, and high pressure compressor blades were damaged.

2.4 Damage to Objects other than the Aircraft

As a consequence of landing roll of the Aircraft only by the wheels after the tires of the nose gear had been disengaged, scratch marks were left on the surface of Runway 34L, and eight runway centerline lights and nine taxiway centerline lights were broken.

2.5 Pilot Information

(1) Captain	Male, Age 39 years	
Airline Transport Pilot Certificate (Airplane)		June 24, 1998
Type rating: Boeing 767		October 13, 1994
Class 1 Aviation Medical Certificate		
Validity		November 9, 2005
Total flight time		7,654 hrs and 50 min
Flight time in the last 30 days		46 hrs and 15 min
Total flight time on the type of aircraft		5,366 hrs and 14 min
Flight time in the last 30 days		46 hrs and 15 min
(2) First Officer	Male, Age 37 years	
Airline Transport Pilot Certificate (Airplane)		June 7, 2004
Type rating: Boeing 767		March 5, 2003
Class 1 Aviation Medical Certificate		
Validity		November 11, 2005
Total flight time		4,138 hrs and 06 min
Flight time in the last 30 days		17 hrs and 52 min
Total flight time on the type of aircraft		772 hrs and 53 min
Flight time in the last 30 days		17 hrs and 52 min

2.6 Aircraft Information

2.6.1 Aircraft

Type	Boeing 767-300
Serial number	28838
Date of manufacture	November 14, 1997
Certificate of airworthiness	No. Dai Tou-11-851
Validity	Until valid date of the Maintenance Manual (Japan Airline International Co., Ltd.) from March 8, 2000
Category of airworthiness	Airplane Transport T
Total flight time	18,288 hrs and 09 min
Flight time since last periodical check (C inspection on December 22, 2004)	1,162 hrs and 07 min

(See Figure 7)

2.6.2 Weight and Balance

It is estimated that the weight and center of gravity of the Aircraft at the time of the serious incident were 259,273 pounds and 24.0% mean aerodynamic chord (MAC), respectively. It is estimated that both were within the allowable range (maximum landing weight of 295,000 pounds and 7 to 37% MAC corresponding to the weight at the time of the serious incident occurrence.)

2.7 Meteorological Information

The aviation periodic weather report (METAR) data at the time of this serious incident at Tokyo International Airport were as follows:

09:30 Direction of wind... 030°; Velocity of wind... 16 kt; Prevailing visibility... 7 km; Current weather... rainy; Clouds: amount... 3/8, type... stratocumulus, ceiling... 700 ft, amount... 5/8, type... stratocumulus, ceiling... 1,000 ft, amount... 7/8, type... altocumulus, ceiling... 1,500 ft; Temperature... 19°C; Dew point... 18°C; Altimeter setting (QNH)... 29.83 inHg

10:00 Direction of wind... 030°; Velocity of wind... 14 kt; Prevailing visibility... 7 km; Current weather... rainy; Clouds: amount... 3/8, type... stratocumulus, ceiling... 700 ft, amount... 5/8, type... stratocumulus, ceiling... 1,000 ft, amount... 7/8, type... altocumulus, ceiling... 1,500 ft; Temperature... 19°C; Dew point... 18°C; Altimeter setting (QNH)... 29.83 inHg

According to the values observed at around 09:59, the time at which this serious incident occurred, the wind direction was approximately 030°, and the wind velocity was between 13 and 18 kt. The two-minute data showed the average wind direction was 045° with margin of 5°, with average wind velocity 14 kt, and the maximum value was 17 kt and the minimum 11 kt.

Moreover, according to the aerodrome meteorological information regarding low level wind shear on June 15 (from 08:55 to 20:55 JST), low level wind shear was forecasted to appear on Runway 34L throughout 09:00 that day, however, no wind shear was observed on the Doppler radar data for the above time period.

2.8 Information on Navigational Aids

At the time of this serious incident occurrence, the instrumental landing system (ILS) and the precision approach path indicators (PAPI) for Runway 34L of Tokyo International Airport were operating normally.

2.9 Information on DFDR and CVR

The Aircraft was equipped with a Digital Flight Data Recorder (DFDR) manufactured by Honeywell Inc. (Part Number: 980-4700-003), in the U.S.A. and with a Cockpit Voice Recorder (CVR) manufactured by Honeywell Inc. (Part Number: 980-6022-001), in the U.S.A.

The DFDR retained records from when the Aircraft departed New Chitose Airport to when it came to a stop after it landed at Tokyo International Airport and this serious incident occurred.

The precise time was determined by comparing the NTT speaking clock retained on the ATC communication records with the DFDR's record of the VHF transmission keying signal during the communications with the ATC.

The CVR is capable of recording audio data for two hours before the equipment stops itself, and it retained the audio data at the time of this serious incident occurrence.

Along with the above-mentioned data, the data recorded on the Aircraft Condition Monitoring System (hereinafter referred to as "the ACMS") was used for analysis.

2.10 Information on the Serious Incident Site

2.10.1 Condition of the Serious Incident Site

From around the area where the nose gear of the Aircraft is considered to have touched down to the point at which the Aircraft came to a stop, multiple wheel debris and tire fragments, as well as some parts of the nose gear were scattered on Runway 34L and on both sides of it. In addition, the right and left tires that were separated from the nose gear were separately found on the runway behind the Aircraft stopping position and on the side of the runway.

From the point where the nose gear of the Aircraft is considered to have touched down to where the Aircraft stopped, marks indicating that the Aircraft rolled only on wheels were left near the runway centerline.

(See Figures 2 and 3)

2.10.2 Details of Aircraft Damage

(1) Nose gear

① Axle and accessory, etc.

The axle was bent upward and backward.

Scratch marks of tire rubber were left inside the wheel mounts of both the left and right axles, and scratch marks were found on both sides of the left axle strut.

② Wheels

The peripheries of both the left and right wheels, both inside and outside, on all circumferences, were broken from their bases, and marks made by the Aircraft's rolling on the ground on the remaining wheels were left, however, the bolts were tightened normally and were not loose.

③ Tires

a Left tire

The left tire was separated from the wheel, and found at approximately five meters behind where the Aircraft stopped. There were marks on the tire indicating it had burst.

b Right tire

The right tire was separated from the wheel, and found at approximately 420 meters behind where the Aircraft stopped. On the inside of the tire, marks which seemed to have been made by bottoming³ were found.

(2) Main landing gear

The inner surface of the inside front tire (No. 3A) of the right main landing gear was partially ripped off, and the pressure of the tire was low.

(3) Fuselage and wings

There were scratch marks, impact marks, and other damages on the left and right sides of the forward fuselage.

There were impact marks on both the left and right nose gear doors, the right wing No.7 and No. 10 leading-edge slat skins, the lower skins of both the left and right inboard tailing edge flaps and the right engine pylon.

(4) Left engine

Impact marks and signs of damage were recognized on the fan case, and broken pieces of wheels were stuck into some of the noise-reduction panels.

A number of fan blades and the blades of the low-pressure compressor and high-pressure compressor were damaged, and some broken pieces of wheels were found inside them.

³ Bottoming means that the tire is crushed and contacts the wheel.

(See Photographs 2, 3, 4, and 5)

2.11 Outline of the Nose Gear

2.11.1 Nose Gear Accessory equipped on the Aircraft

- | | |
|---|-------------------|
| (1) Shock strut (Part Number: 162T0000-227 Serial Number: S601) | |
| Date of overhaul | October 14, 2003 |
| Date of installation | October 18, 2003 |
| (2) Left wheel (P/N: 2606735-1-22 S/N: B-2159) | |
| Date of overhaul | April 9, 2005 |
| Date of installation | April 10, 2005 |
| (3) Right wheel (P/N: 2606735-1-22 S/N: B-1780) | |
| Date of overhaul | December 25, 2004 |
| Date of installation | May 26, 2005 |
| (4) Left tire (P/N: S160T201-413 S/N: 704GE046) | |
| Date of installation | April 10, 2005 |
| (5) Right tire (P/N: S160T201-412 S/N: 202YY001) | |
| Date of installation | May 26, 2005 |

2.11.2 Maintenance History of the Nose Gear

- (1) Neither Airworthiness Directive nor Service Bulletin required to be implemented on the Nose Gear equipped on this Aircraft had been issued.
- (2) No trouble during the operation on nose gear, wheels and tires had occurred within the six months just before the date of this serious incident.

On tire maintenance, it was requested to check the conditions of abrasion and cutting between the each flight and after operational closure, and to check the inner pressure once a day. All checks on the Aircraft mentioned above had been implemented at New Chitose Airport at the timing of operational closure on the previous date of this serious incident, and it had been confirmed all normal.

- (3) Requirements and implementation history of maintenance on each component of nose gear
 - ① Overhaul interval on nose gear: Earlier timing of either eight years or 12,000 landings
The nose gear of the Aircraft: It had passed one year and eight months with 3,015 landings after equipped on the Aircraft, and total number of landings on the Aircraft: 22,022 times
 - ② Overhaul interval on nose gear wheels: 1,000 landings
Left wheel of the Aircraft: Number of landings was 331.
Right wheel of the Aircraft: Number of landings was 110.
 - ③ Although there were no legislation requirement and the company's maintenance requirement on number of times on tire recapping, it was prescribed that acceptable maximum number of times on tire recapping was six times in the specification document of the technology requirements that the Company had required the tire manufacturer company. Recapping numbers of times on those tires equipped on the Aircraft were zero and five times, on left side and right side respectively.

2.12 Fact-Finding Test and Research

2.12.1 Analysis of Airframe Movement with Numerical Simulation

To analyze the movement of the Aircraft at the moment of touchdown, the Japan Aerospace Exploration Agency (JAXA) had conducted flight simulations from July 2005 to February 2008 on request. ACMS data during the occurrence of the serious incident and the airframe mathematical model for training simulator provided by the manufacturer of the Aircraft were used.

The results of the analysis were as outlined below.

- (1) Although a cross wind of between 15 and 20 kt was blowing at heights of 500 ft and above, the cross wind became weaker at heights of below 500 ft, and it is considered that the cross wind at the time of touchdown was less than 5 kt. There has a prone that a sideslip of airframe is formed, and cross wind will be estimated smaller, because the nose heading is generally aligned to the runway direction just before touchdown. But this time, it is considered that the change of nose heading at the last minute of touchdown was minor, and that it had only a small effect.
- (2) Prior to touchdown, the pitch angle varied every 4 to 6 seconds with approximately plus or minus of 1° amplitude, however, as the affect of air disturbance was minor, it is considered that the elevator control was the main cause.
- (3) Regarding the sequence of touchdown, the main landing gear touched down first and bounced, but the record of the DFDR showed that it remained on the ground. The nose gear touched down before the entire Aircraft's weight was put on the main landing gears, at which time the nose gear started to break, because the pitch attitude started to gradually decrease approximately just before the main landing gears touched down again. The main landing gears touched down again on the ground at about the same time as the nose gear broke.
- (4) Assuming that the airframe was a rigid body, the vertical load applied on the nose gear at the moment of touchdown was estimated to be 255,000 pounds. Assuming that the fuselage deformation at touchdown acted in the direction in which the nose gear load would result in the smallest, the nose gear load was estimated to be 214,000 pounds. The estimation results showed a load that was conveyed from the nose gear to the fuselage, and the flight simulation cannot handle a load that was absorbed through the deformation of an airframe and landing gear, the fracture of wheels, etc., and thereby was not conveyed to the fuselage, such a load was not included in the estimation results. Therefore, it is considered that a load larger than these estimation results was actually applied to the nose gear wheels.

2.12.2 Analysis of the Nose Gear Wheels

In order to confirm the soundness of the nose gear wheels equipped on the Aircraft, the Japan Aerospace Exploration Agency (JAXA) had performed an investigation, from August 2005 to December 2007 on request.

At JAXA, broken surfaces of typical portions of the left and right wheels were cut out and examined with a scanning electron microscope (SEM). The results are as outlined below.

No defects were observed throughout all portions of the materials, and wave patterns that typically appear on a fracture surface in case of fatigue breaking were not confirmed. Furthermore, no appearance indicating the origin of breaking was confirmed, and dimple patterns⁴ were

⁴ The unique appearance of dimples which is made on fracture surfaces when ductile fracture occurs.

confirmed extensively on all fracture surfaces, therefore it is judged that a ductile fracture⁵ occurred.

2.12.3 Analysis of the Nose Gear Tires

In order to examine the evidence of abnormality in the properties of the tires attached to the Aircraft during the occurrence of this serious incident, the arrangement of components used (the number of components, gauge, etc.) and the physical properties of the material used were checked at the tire manufacturer's factory in the presence of the investigators of this serious incident (March to October, 2007).

(1) Investigation of cut samples

After cutting out the samples of tires in a cross sectional direction, the structural arrangement of the tires (tread, sidewall, bead, ply, etc.), gauge (thickness), and the number of components were checked to see whether the tires were made in compliance with the specifications. The results showed that the arrangement, dimensions, and the number of components were within the standard.

(2) Investigation of quality

① Textile cord and bead wire properties

After cutting out the samples of the nylon textile cords comprising ply components and the metallic bead wires of the bead part, which are aggregates of the tire and retain the strength of the tires against internal pressure and external stress, tensile test was conducted to check the strength, but no abnormalities were found.

Moreover, the extent of the damage was investigated for each layer of the textile cord when samples were removed. The results showed that the right tire received extensive damage to the outboard and the left tire received damages on both the outboard and inboard.

② Rubber properties

During manufacture, the elasticity and strength required for tire rubber is obtained by applying heat treatment after mixing raw rubber with sulfur, and non-reactive sulfur exists inside the tire even after manufacture. If the heat stimulus grows higher during rolling, the residual sulfur reacts to the heat and it comes up to deteriorate the elasticity and strength of tires.

Therefore, in addition to conducting a tensile test on the tread rubber that makes contact with the runway surface to confirm the break elongation and break strength, the heat history of the rubber was analyzed. As the result of the investigation, no abnormalities were found concerning the break elongation and break strength of the rubber of both the left and right tires, nor was deterioration of the rubber observed in the heat history.

(See Photo 4)

2.12.4 Implementation of Actual Load Strength Tests for Nose Gear Wheels and Tires

In order to clarify the cause and circumstances in which the wheels were broken and the tires were disengaged, strength tests of the wheels and tires were conducted using the wheels and tires normally used for the Aircraft type, in presence of the aircraft incident investigators and

⁵ Metallic materials are generally deformed to a certain extent when stress is applied, and then destroyed. Breaking of such fragile materials as ceramics or glasses is called brittleness fracture, while the fracture with such deformation is called ductile fracture.

expert advisors at the factory of the tire manufacturer (November 2005 to January 2006).

The first test was conducted using iron wheel that have significantly high rigidity (hereinafter referred to as “the rigid wheel”), within the range of the testing load.

A tire normally used for the Aircraft type (hereinafter referred to as “the actual tire”) was attached to the rigid wheel, and the load applied and amount of displacement of the tire were measured until bottoming of the tire occurred, by changing the internal pressure of the tire, using testing equipment.

In the second test, the actual tire and the wheel normally used for the Aircraft type (hereinafter referred to as “the actual wheel”) were assembled and attached to the testing equipment, and the distortion of the actual wheels against the load applied was measured per pressure setting in the tire and per each wheel inclination of 0°, 2.5°, and 5°.

The results of the tests revealed the following points:

- (1) The relationship between the load and amount of displacement of the actual wheel roughly corresponded to the relationship between the load and amount of displacement in the case of using the rigid wheel under the same internal pressure.
- (2) Based on the result of (1) above, it is estimated that the bottoming load under the normal pressure (165psi) of the tire is approximately 76,000 pounds, and that if the internal pressure becomes lower than this, the bottoming load would also become smaller. It is estimated that these values are lower than the wheel yield load of 83,800 pounds.
- (3) By applying the distortion obtained by the second test, the distortion and stress generated by the bottoming load (about 76,000 pounds) under the normal tire pressure, which was estimated from the result of the first test, were calculated. As a result, it was estimated that the distortion and stress that would cause the wheel to be destroyed were not generated.

From the above-mentioned findings, it was made clear that wheels would not be destroyed unless bottoming occurred to tires.

2.13 Additional Information

2.13.1 Qualifications for Flight Crewmembers of the Company

(1) With respect to the left seat approved captain, “the QUALIFICATIONS MANUAL Chapter 6 Qualified Captain” describes as follows:

6-8 Left Seat Approved Captain

Qualification requirements of left seat approved captain (qualified captain who are able to let qualified first officers conduct left seat maneuvering) shall be as follows.

- 1. Flight time of jet plane captains shall be more than 800 hours, and in addition, flight time on the relevant aircraft type shall be more than 200 hours or 100 legs. However, in a case where he or she has more than two-years experience as a left seat approved captain on other aircraft types (including experiences in JAA/JAZ/JEX/JTA), flight time on the aircraft type shall be more than 100 hours or 50 legs.*
- 2. Training shall be completed based on the training standards for left seat approved captain as listed below.*
- 3. Designation of left seat approved captain by flight crew manager of the relevant aircraft type shall be conducted.*

Table 6-8 Training Standard for Left Seat Approved Captains

<i>Current qualifications</i>
<i>R/S Approved CAP</i>

<i>Training and examination items</i>		<i>Targeted qualification and limitation</i>	<i>Note</i>
		<i>L/S Approved CAP</i>	
<i>Ground School</i>		<i>7HR</i>	
<i>FFS</i>	<i>Training</i>	<i>3HR [Std] at R/S</i>	<i>(Full Flight Simulator)</i>
<i>Line</i>	<i>Training</i>	<i>2LEG [Std] at R/S</i>	<i>1LEG as PF, 1LEG as PNF</i>

[Note1] In case of aircraft type change, the above training for the aircraft type after the change will be conducted. However, in case of qualified left seat approved captains on the aircraft type before the change (including experiences in JAA/JAZ/JEX/JTA), Ground School 4HR and FFS 1HR can be omitted.

[Note2] In case of the captain qualified who is going to continue duty on the aircraft after reinstatement, return, transfer and loan, all trainings described above can be omitted if the captain has the experience of left seat approved captain on the same aircraft type in JAA/JAZ.

[Note3] In case of captain who completed flight instructor appointment training and line flight instructor appointment training, all trainings described above can be omitted.

[Note4] In the training of left seat approved captain, the approach and landing training shall be implemented at least one time on right seat of the FFS under the CAT-1 meteorological condition.

(2) The captain was authorized as the left seat approved captain on February 22, 2002, and he has performed approximately 1,845 hours of flight operation since then.

(3) The first officer was assigned to engage in the pre-left training, which was to be carried out for about one year before being assigned to the left seat line training, on June 2, 2004, and has performed approximately 185 hours of flight operation during 85 legs.

(4) The first officer, who had taken a hiatus from flight from February 2 to May 10, 2005, has conducted return training such as self-study of 2 days, simulator training of 4 hours and line training of 4 legs when he resumed flight based on the Qualifications Manual.

(See Figure 6)

2.13.2 Standard Callout Described in AOM (1) NORMAL PROCEDURES

	<i>Flight Phase</i>	<i>Standard Callout</i>	
		<i>PF</i>	<i>PNF</i>

Omitted	Omitted	Omitted	Omitted
<i>DESCENT,</i>	<i>Field Elev.+1,000ft</i>	<i>Raw Data</i>	<i>One Thousand</i>
<i>APPROACH &</i>	<i>Field Elev.+500ft</i>	<i>Stabilized</i>	<i>Five Hundred</i>
<i>LANDING</i>	<i>AH⁶+100ft</i>	<i>Check</i>	<i>Approaching Minimum</i>
	<i>AH(alert height)</i>	<i>Landing</i>	<i>Minimum</i>
	<i>FLARE Engage</i>		<i>Flare</i>
<i>LDG ROLL</i>	<i>ROLLOUT Engage</i> <i>80kt</i> <i>60kt</i>		<i>Rollout</i> <i>Eighty</i> <i>Sixty</i>

2.13.3 Landing Roll Procedure Described in AOM (1) NOMAL PROCEDURES

<i>PF</i>	<i>PNF</i>
<i>Monitor ROLLOUT progress and proper auto brake operation.</i>	
<i>Verify thrust levers closed and SPEEDBRAKE up. Without delay, raise thrust levers to reverse idle position. If SPEEDBRAKE lever failed to extend automatically, extend speed brake manually.</i>	<i>Verify SPPEEDBRAKE lever UP and call "Speed brake up." If speed brake lever not UP, call "No speed brake."</i>
<i>Apply reverse thrust as required.</i>	<i>Verify REV on EICAS is green.</i>
<i>By 60 kt, initiate movement of the reverse thrust levers to reach the reverse idle by taxi speed. Position levers to full down (forward thrust) when engines have decelerated to reverse idle.</i>	<i>Call "eighty," "sixty."</i>
Omitted	Omitted

2.13.4 Operational Range of Control Column

According to the Aircraft Maintenance Manual (AMM) of the Company, the operational range of the control column of the Aircraft is as given below.

- Left pilot seat: 8.75 to 9.00° forward from the neutral position
11.00 to 11.25° backward from the neutral position
- Right pilot seat: 8.25 to 8.50° forward from the neutral position
10.67 to 10.90° backward from the neutral position

2.13.5 Range that Air/Ground Sensor indicates GROUND

The tilt sensors, which detect the ground when the tilt angle becomes less than 17°, are attached to the inner cylinder of the main landing gears of the Aircraft, and the sensors function as

⁶ AH is a specific height established for CATIII operation and it means a height from the touch-down point, which is established for the aircraft equipped with the Fail-operational Automatic landing system.

outlined below.

Up until the main landing gear tires touch down on the runway, the struts are extended at maximum and the posture of main landing gear bogie tilted at 17° toward the lower front, on condition that the horizontal is 0°. Under such a condition, the air/ground sensors detect air, and “AIR” is recorded on the DFDR.

When the main landing gears touch down on the ground and the tilt starts to be dissolved, the air/ground sensors detect the ground and “GROUND” is recorded on the DFDR, and also when the struts compress and the tires dent, the range thereof covers the ground condition.

Therefore, the range in the air/ground sensor records ground condition is approximately 82 cm, which is obtained by adding the length of the strut changed from full extension to full compression (about 57 cm) and the tires’ dent (about 4 cm) to the vertical length of the tilt at 17°(about 21 cm).

The range in which the ground condition is detected and recorded is smaller than approximately 82 cm, because the struts would not be fully compressed under normal conditions, including the landing on this serious incident.

2.13.6 Maximum Value of Cross Wind at Take-off and Landing (Average Wind)

According to the Aircraft Operation Manual for the Aircraft, the acceptable maximum cross wind value was 25 kt on condition Runway 34L at the time of this serious incident occurrence was wet.

2.13.7 Foreign Object Debris on Runway 34L

On the basis of the inspection of the runway immediately after the occurrence of this serious incident, no foreign object debris considered to have contributed to this serious incident were found.

2.13.8 Information from the State of Design and Manufacture

The data recorded on the DFDR which was dismantled from the Aircraft after this serious incident was sent to the National Transportation Safety Board of the United States, the State of Design and Manufacture of the Aircraft, and to the manufacture of the Aircraft.

As a result, the following comments were submitted.

- (1) This event (this serious incident) had similar characteristics to several previous events, mainly a bounced landing followed by an abrupt nose down elevator. This resulted in an exceedance of the nose gear tire bottoming load, nose gear axles yield load and very likely an exceedance of the nose wheel ultimate load. Previous events involving Boeing 767s have resulted in nose gear damage and forward fuselage damage, although this is the first reported instance of nose wheel fracture.
- (2) The nose wheel itself is tested to ensure it can withstand loads up to ultimate load.
- (3) The safety relief valve is not designed to protect tires or wheels from excessive pressure applied instantaneously by external loads such as hard landings.
- (4) The peak load on the nose gear was estimated at 218,000 to 260,000 pounds based on the vertical acceleration, the pitch acceleration, the lift, the weight and the center of gravity. This load exceeds the nose gear axle yield load of 210,000 pounds. This load also exceeds the single tire bottoming load of 63,000 pounds, and likely exceeded the single

nose gear wheel ultimate load (109,400 pounds).

- (5) The load did not exceed the structural capability of the fuselage.

3 ANALYSIS

3.1 Qualifications, etc., of Flight Crewmembers

The captain and the first officer possessed both valid airman certificates and valid aviation medical certificates. Moreover, the captain and the first officer fulfilled the requirements described in the Qualifications Manual of the Company.

3.2 Airworthiness Certificate, etc. of the Aircraft

The Aircraft had a valid airworthiness certificate and had been maintained and inspected properly.

3.3 Weather and Other Contribution

With regard to the fact that, at the time of this serious incident, the pitch angle of the Aircraft varied remarkably prior to touchdown, it is considered likely that the turbulence, which aircrafts typically encounter during the landing on Runway 34L of the Airport, in the form of cross wind from the right direction as described in 2.7, affected the maneuvering of the first officer.

However, as described in 2.1.2, the captain and the first officer of the Aircraft had confirmed the influence of the turbulence 15 minutes before starting the descent.

Also, ① As described in 2.1.2 (1), the captain stated that “there had been no problems with the operation up to that point when the main tires touched the ground, and his handling was acceptable.”

② As described in 2.1.2 (2), the first officer who was maneuvering stated that “turbulence did occur from a height of about 100 ft, but it was more or less the same as what we normally experienced.”

③ As described in 2.1.3 (3), the deputy senior CA stated that there was a feeling of a light turbulence, and as described in 2.1.4 (3), passenger C stated that “the aircraft quaked and rattled in small and short motions.”

Judging from the above, although there is a possibility that the main landing gear touched down on the ground somewhat hard as the turbulence affected the Aircraft during the landing, it is presumed that the extent of their effects on this serious incident was minor.

3.4 Soundness of the Nose Landing Gear Tires and Wheels

- (1) As described in 2.11.2 (2), the nose landing gears were inspected for internal pressure on previous day of this serious incident, while the Aircraft was parked at New Chitose Airport. As described in 2.1.2 (2), the PF checked that there were no abnormalities, during the pre-flight external inspection on the day of this serious incident. Furthermore, as described in 2.1.2 (2), the captain stated that he did not feel that anything was unusual during the take-off roll at New Chitose Airport. Therefore, it is estimated that the normal condition was maintained until the landing at Tokyo International Airport.
- (2) Based on the analysis of the wheels as described in 2.12.2, it is estimated that the nose wheels attached to the Aircraft were normal.
- (3) Based on the investigation of the quality of the tires as described in 2.12.3, it is estimated that the nose tires attached to the Aircraft were normal.

3.5 Maneuvering conducted from Approach to Stop

3.5.1 Approach

- (1) As described in 2.1.1, the Aircraft was flying on the final approach course at an approach speed of approximately 140 kt (CAS) by the manual operation of the PF.

To the “500 ft” call by the PNF, the PF responded “Stabilized,” and to the “Minimum” call by the PNF, the PF responded “Landing,” then the PNF advised the PF to “just keep this heading.”

The DFDR records support that it was the stabilized approach, therefore it is estimated that there were no problems with the flight around that time.

- (2) As described in 2.1.1, after the “Minimum” callout, the roll angle and pitch angle of the Aircraft started to fluctuate significantly from a height of approximately 300 ft till touchdown. As described in 2.1.2 (2), it is estimated that the beginning of these fluctuations correspond to the time at which the PF caught the runway in sight and started finally to make an approach by mainly looking outside.

- (3) The pitch angle fluctuated in a cycle of 4 to 6 seconds, and the fluctuation began to amplify from a height of approximately 150 ft downward, and it is considered likely that it was viewed generally due to the operation (operated back and forth in short time intervals) of the control column. Furthermore, as described in 2.1.2 (2), the PF stated “there was turbulence which was affected by it”. Therefore it is considered likely that the PF operated the control column back and forth in a quick manner in order to respond the turbulence generated on the lee of the hanger.

- (4) As described in 2.1.1, the CCP (1.05° , -1.41° , -2.11° , 0.35° , -1.05°) changed mostly forward from the latter half of 59m:08s to the latter half of 59m:10s, and the pitch angle (2.8° , 2.5° , 1.8° , 1.4° , 1.1° , 0.7° , 0.7° , 0.7°) changed from the latter half of 59m:09s to the latter half of 59m:11s. It is estimated that the operation of CCP caused the pitch angle to change in a time lag. After that, it is estimated that the CCP changed mostly backward (-1.05° , 2.46° , 1.76° , 2.81° , -0.35° , 3.87°) from the latter half of 59m:10s to the first half of 59m:13s, and the pitch angle, again in a time lag, changed from the latter half of 59m:11s to the first half of 59m:14s (1.4° , 1.8° , 1.8° , 2.8° , 3.2° , 3.5° , 3.5° , 3.9° , 4.2° , 4.6° , 4.9°). It is estimated that the CCP changed from 3.87° to 2.81° at 59m13s, because the pitch angle continued to increase, and it is estimated that the pitch angle started to decrease at 59m14s from 4.9° to 4.6° accordingly. As described before, it is estimated that the movement of the control column corresponded (was linked) to the change in the pitch angle, however, it is estimated that the pitch angle changed in a time lag in correspondence to the movement of the control column.

3.5.2 Touchdown

- (1) As described in 2.1.1, the flare operation for landing was started from at around 59m:11s and the pitch angle changed from 0.7° to 4.9° , however, the thrust was undergoing a transition of about 61% (N1). Therefore it is estimated that the thrust lever operation accompanying a large thrust change was not performed.

At 59m:13s, the CCP changed from 3.87° to 2.81° , and the pitch angle decreased from 4.9° to 4.6° during the latter half of 59m:14s in a time lag, but the pitch angle was tending

to increase (3.9° to 4.2°) when the CCP was at 2.81° and was still increasing (from 4.6° to 4.9°) when the CCP was at -3.16° at the first half of 59m:14s. Therefore it is considered likely that the PF continued to operate the control column forward to respond above situation. Moreover, it is considered possible that the PF operated unintentionally the control column forward by responding against the condition that the main landing gear touched down firmly at that time.

- (2) The pitch angle at the time the air/ground sensor detected the ground, after the main landing gears of the Aircraft touched down at 59m13s, was about 4.2°, and the vertical acceleration was 1.478G. Immediately after that, as three flight crewmembers stated in 2.1.2, a load (1.607G) slightly larger than that of a usual landing was applied, but it is estimated that the main landing gears touched down on the ground safely at this point.
- (3) Approximately one second after the touchdown, the control column was operated forward (the CCP was -3.87°), and the pitch angle was 4.6°. It is estimated that the Aircraft bounded (0.258G), because even after it touched down with rather a large load, the pitch angle increased up to 4.9° and the CAS was also slightly fast at 139kt. As the DFDR record remained in the ground condition at that time, it is estimated that the height was not high enough to make the tilt angle of the main landing gear reach 17° and be recorded as AIR on the DFDR, namely the tires were not completely lifted up from the surface of the runway.

Approximately one second after the touchdown, the speed brake began to extend, but the pitch angle already started to decrease around that time.

- (4) The forward operation (3.87°, 2.81°, -3.16°, -3.87°) of the control column started immediately before the touchdown, and the amount of operation decreased temporarily at 59m:15s (the CCP was -1.41°), but the nose continued to lower to result in the pitch angle of -0.7° with the control column operated forward (the CCP was -7.03° [70 to 80% of allowable forward operation]), and it is estimated that the vertical and longitudinal accelerations marked the highest values (3.442G, -0.283G) during this serious incident.
- (5) According to the statements of 2.1.2 (1) and (2), both the captain and the first officer stated that they were trying to hold the control column but eventually gave in, and the nose dropped. However, during the actual operation according to the DFDR record, the CCP turned to -1.41° temporarily, and the operation pushing the control column forward continued (an operation similar to suppress the nose wheels downward on the ground the CCP was -7.03°) with amount of control column operation decreased, and a witness stated in an interview that “The nose sank once significantly.” Judging from these, it is estimated that the pitch angle, which was at 4.9° immediately after the touchdown, turned to -0.7° one second later. It is estimated that the acceleration was applied in the longitudinal direction, and -0.283G acceleration was applied when the nose gear was destroyed, while in the process that the pitch angle was lowered and the nose gear touched down the ground.
- (6) According to the fact that the time at which the maximum vertical acceleration was recorded corresponded to the time at which the breaking sound was recorded on the CVR, it is estimated that the both wheels and both tires of the nose gear were destroyed at about the same time.

It is estimated that the control column was operated forward significantly and the pitch

angle of the airframe became -0.7° at the time described above, furthermore, the nose wheels ran into destruction getting direct impact strength on the wheels after the right tire bottoming and the left tire burst, caused by an excessive load being applied on the nose gear before the weight of the Aircraft being placed on the main landing gear completely.

- (7) When the main landing gears make a touchdown rather hard just like the case of this serious incident, it is necessary to operate the control column to retain the aircraft attitude once, and to operate accordingly the control column in accordance with the aircraft attitude so that the nose gear can be placed on the runway, while the elevator control is sufficiently effective.

3.5.3 After Touchdown

Despite the control column being kept operating forward significantly after the nose gear touched down on the ground (-8.79° , -7.03° , -7.73° , ...), as described in 2.1.5, the witness stated that "I could see the nose vibrating in a movement different from usual, and it repeated pitching twice or so." Furthermore, the pitch angle of -0.7° recorded on the DFDR also increased to 1.4° . Judging from these, the impact at the time when the nose gear made the first touchdown was intense, and the nose gear made an up-and-down movement in reaction. However, it is estimated that the nose gear did not bound in the air from the runway surface, because the sound of impact continued incessantly on the CVR record.

It is estimated that the auto brake started to operate 0.5 seconds after the touchdown of the nose gear and the thrust reverser started to operate one second after that touchdown, and the Aircraft rolled only on wheels without tires and then stopped.

The post-touchdown "Speed brake up" call normally performed by the PNF was carried out 17 seconds after the speed brake had actually started to operate, moreover, the calls at speeds of 80 and 60 kt had not been conducted, therefore it is estimated that the normal procedures were unable to be conducted in the cockpit due to the intense aircraft movement and noise.

3.6 Process Leading to the Nose Tires and Wheels Destruction

3.6.1 Load Applied on the Nose Gear

The vertical acceleration of 3.422G was recorded on the DFDR at the time of nose gear touchdown. As described in 2.12.1 (4), the load applied on the nose gear at that time in the vertical direction would be 255,000 pounds, assuming that the airframe is a rigid body, and would be 214,000 pounds even if the fuselage modification at touchdown worked in the direction to result the nose gear load at touchdown in the smallest, therefore it is considered highly likely that the load applied on the nose gear exceeded the ultimate wheel load of 109,400 pounds $\times 2$.

3.6.2 Main Factor of the Wheel Destruction

It is estimated that the bottoming of the tires occurred first and then the wheels were destroyed, because marks of bottoming were found inside the right tire by the appearance inspection on tires, and also because, based on the result of the actual load strength test described in 2.12.4, it is considered likely that the wheels would not be destroyed unless the bottoming of tires occurs.

As for the left tire, it is considered possible that a shock burst¹, etc., had occurred, because

¹ When an excessive shock is applied to part of a tire, the high-pressure gas inside the tire blows out momentarily

there was a mark consistent with bursting.

It is estimated that both of inboard and outboard rims of the right wheel and the inboard rim of the left wheel were destroyed almost simultaneously the instant the nose gear touched down on the ground, and rolled for a while in a condition in which the outboard rim of the left wheel remained, and then the outboard rim of the left wheel was eventually destroyed, because there was a mark of damage only on the outboard rim of the left wheel, which indicates that the left wheel rolled on the runway surface.

3.6.3 Order on Disengagement of the Nose Gear Tires

Judging from the damages on the left and right tires and wheels, the order on disengagement of the tires is considered as follows:

(1) Right tire

Bottoming occurred on the right tire at the same time as the nose gear touched down, and the rims of both sides were destroyed. The internal pressure of the tire was lost, and the tire inner bead (on the strut side) was pushed up on the axle once, but then the tire dropped off.

(2) Left tire

Burst occurred on the left tire simultaneously when the nose gear touched down. The tire inner bead was pushed up on the axle, because the inboard rim was destroyed. The tire outer bead was also pushed up on the axle. It continued to roll for a while only with the outboard rim, and then the left tire dropped off, because the outboard rim was also destroyed.

4 PROBABLE CAUSE

This serious incident occurred as the Aircraft landed on Runway 34L of Tokyo International Airport, it is estimated that it bounded on its first touchdown and then the nose gear touched down before the Aircraft weight was completely placed on the main landing gears again, and that an excessive load was placed on the nose gear, and consequently, the nose gear damaged, and the Aircraft went into the condition unable to taxi by itself.

With regard to the nose gear touched down before the Aircraft weight was completely placed on the main landing gears, it is estimated that an excessive forward operation of the control column was the most significant factor.

Figure 1 Estimated Flight Route

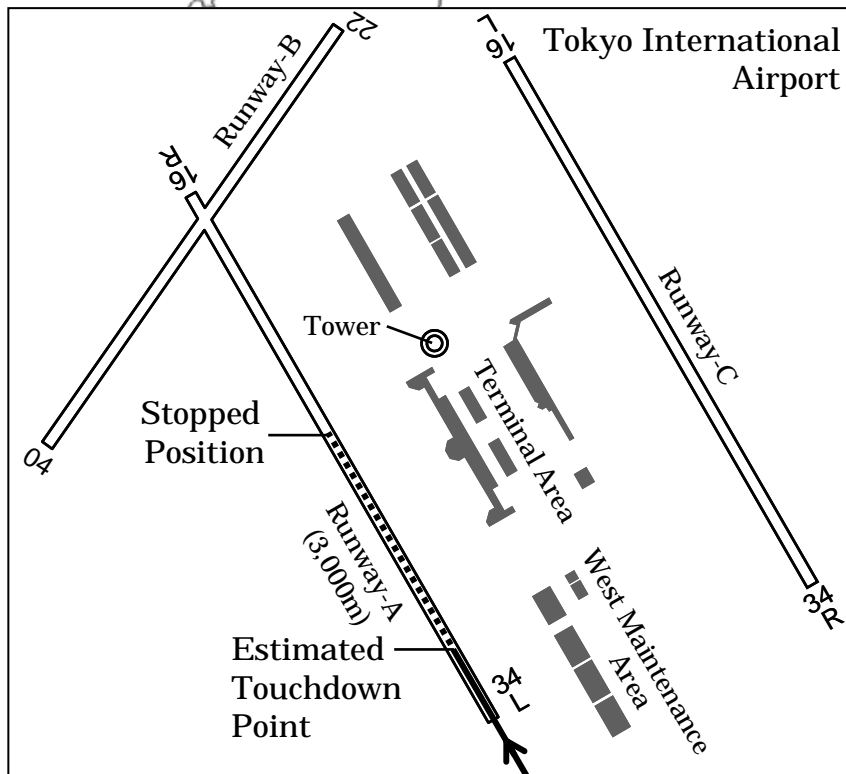
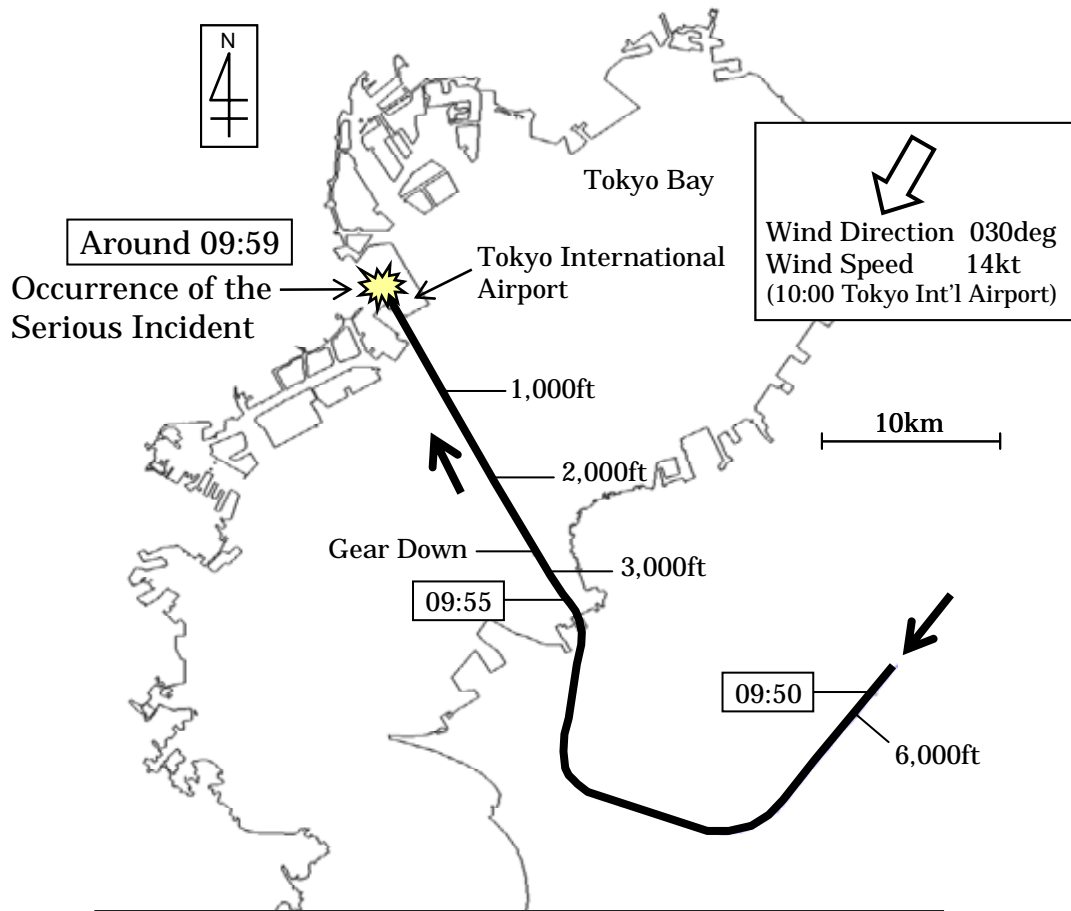

Figure 2 Scattered Debris

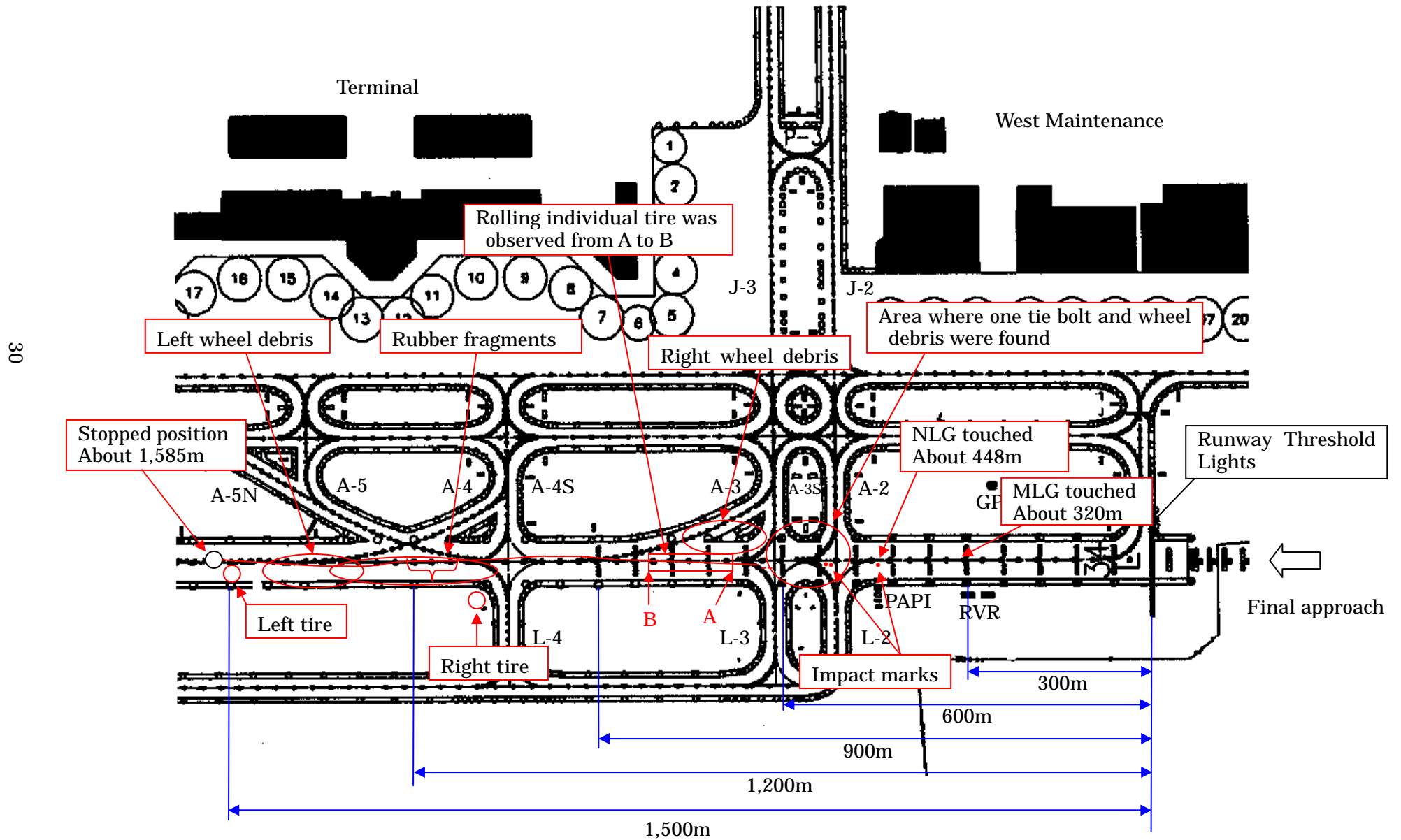

Figure 3 Marks on Runway Surface

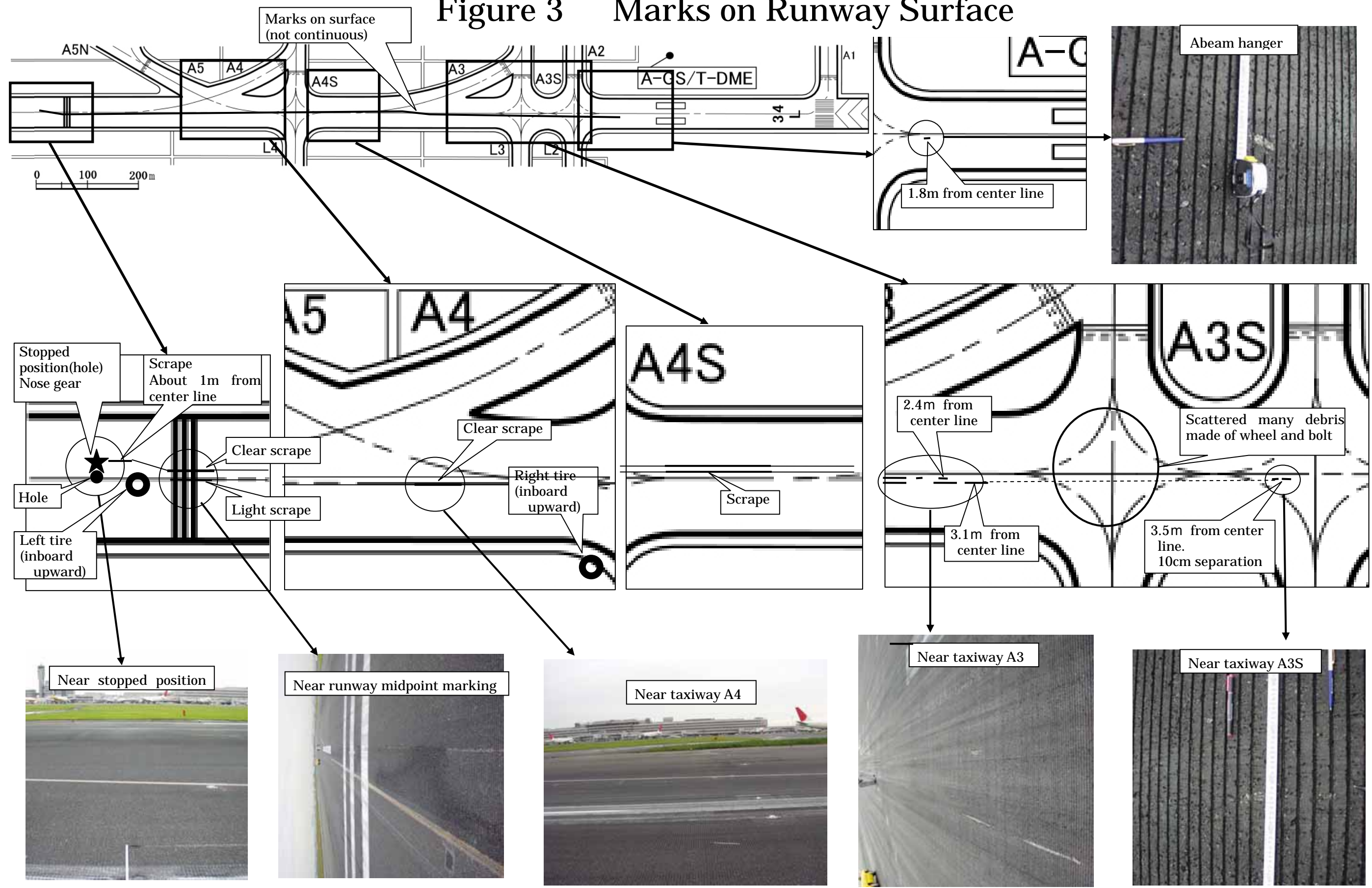
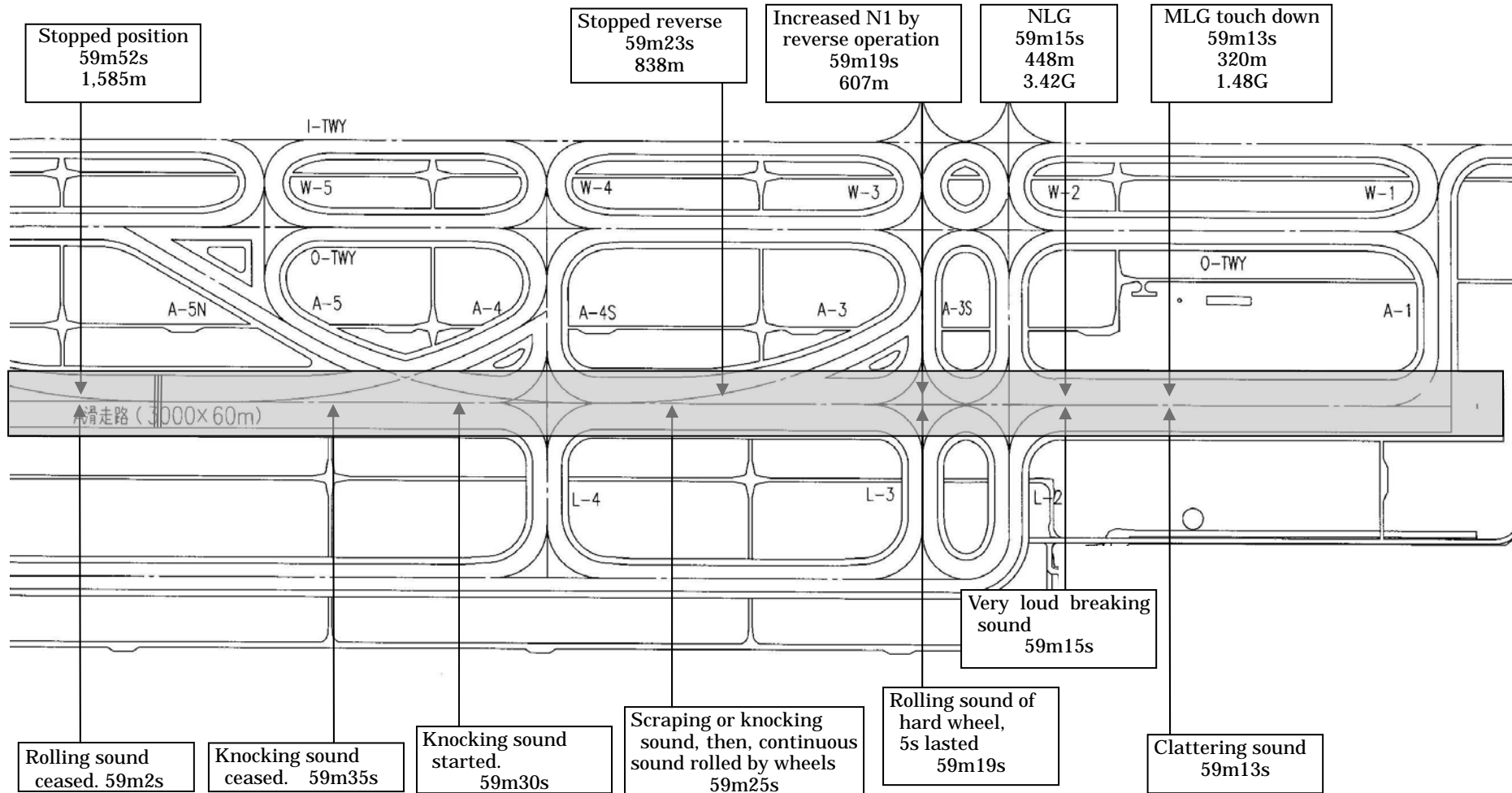

Figure 4 Situation of the Aircraft Stop



Uppers are based on DFDR, lowers are based on CVR

Figure 5-1 DFDR Records 1

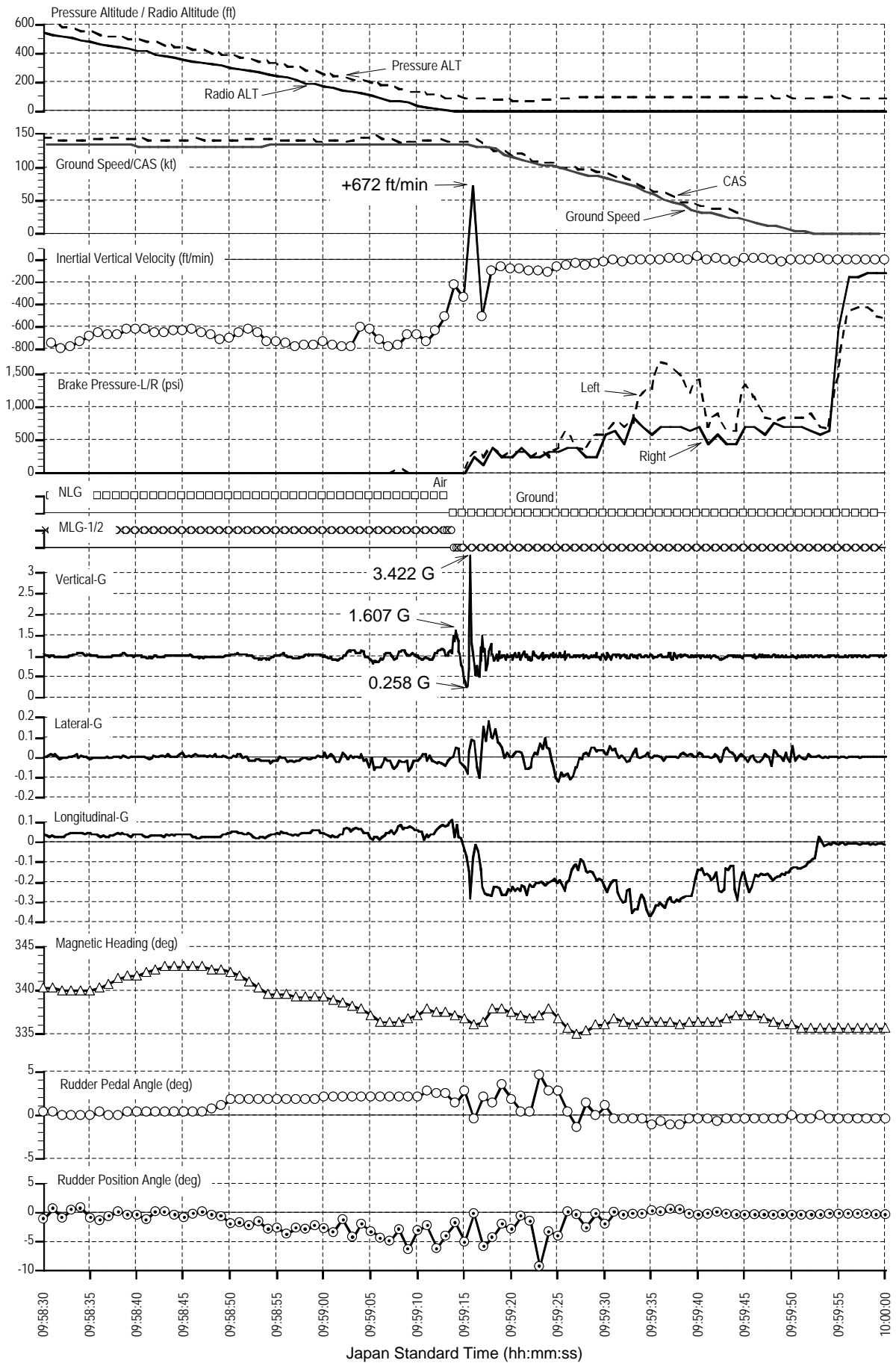

Figure 5-2 DFDR Records 2

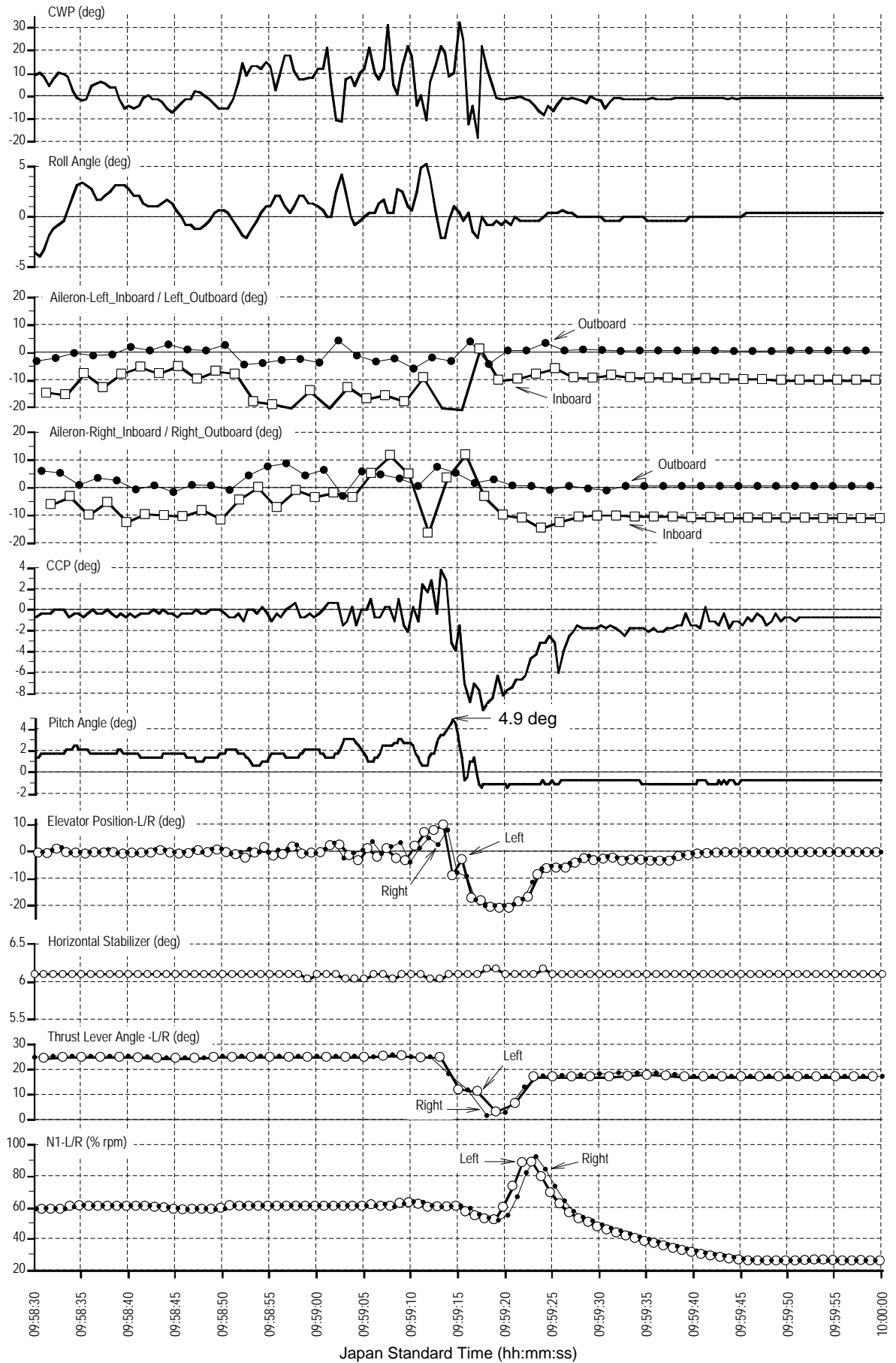

Figure 5-3 DFDR Records 3 (Just touch down)

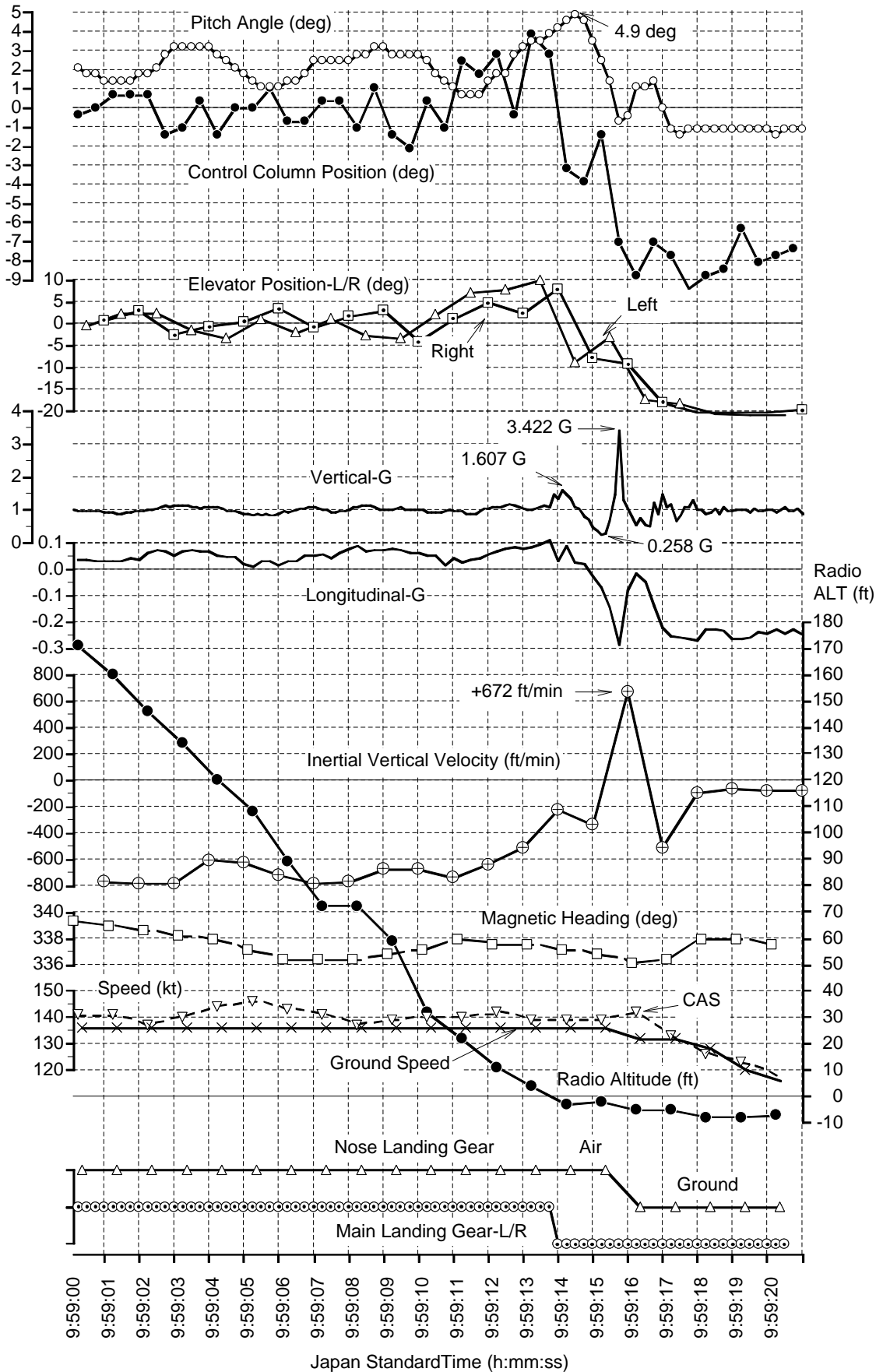

Figure 6 Captain Promotion Flow Chart

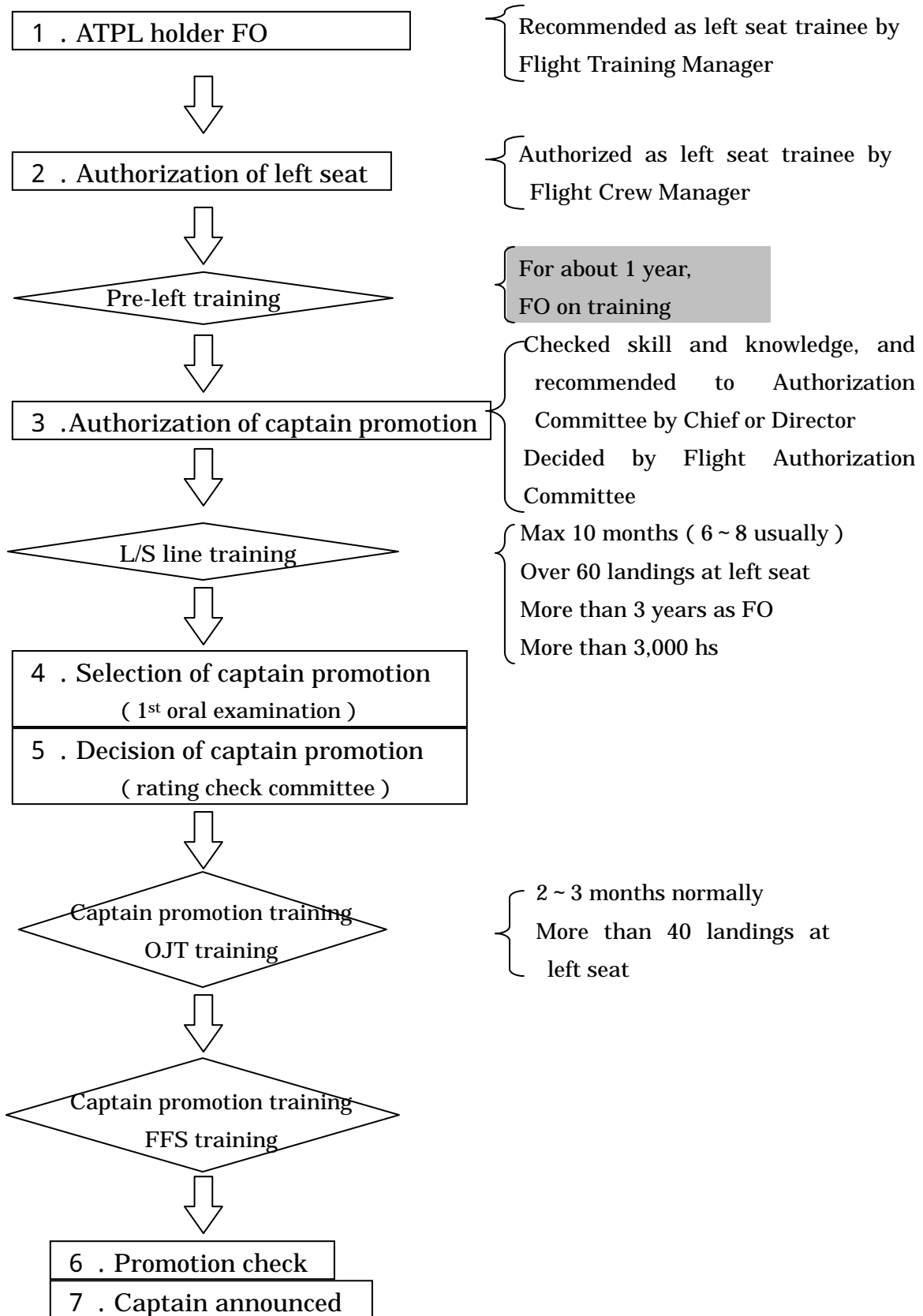
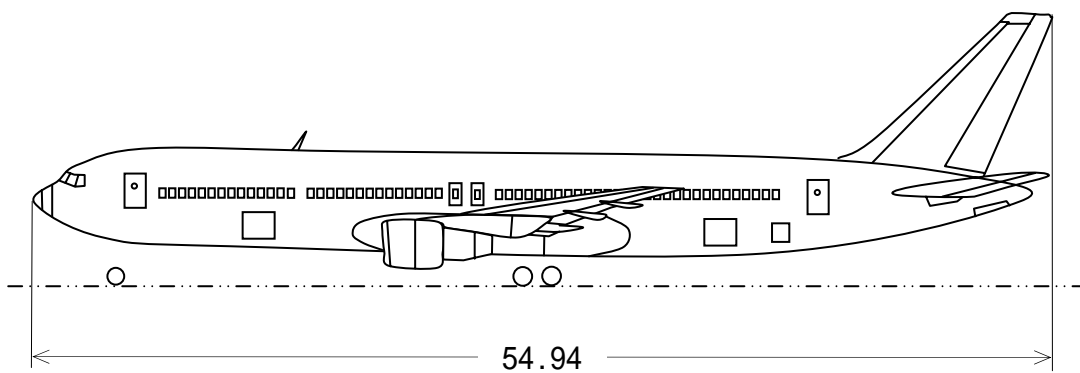
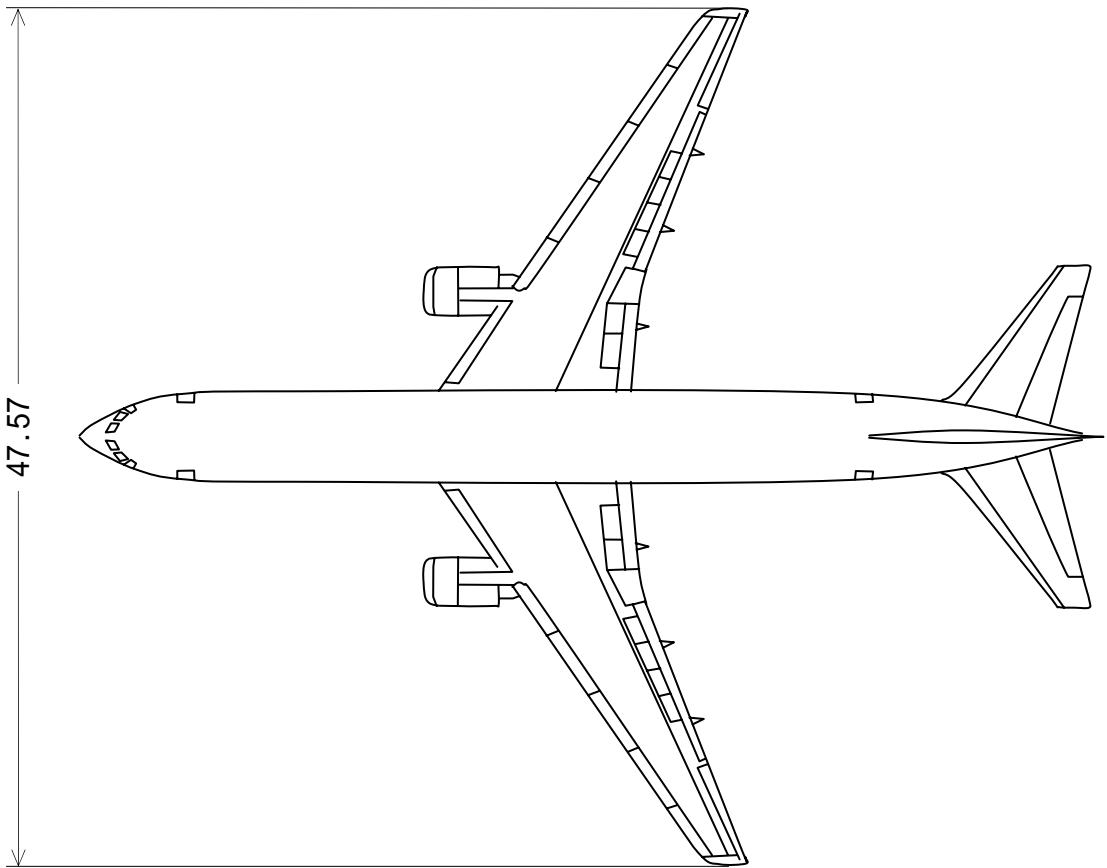
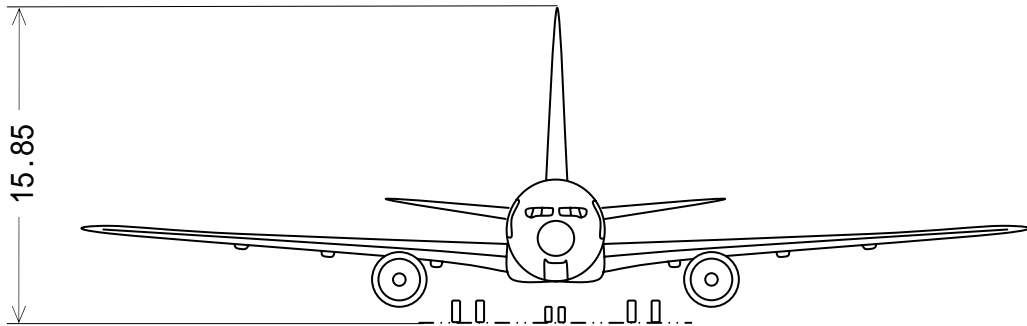

Figure 7 Boeing 767-300 3-Dimensions

unit : m



Photograph 1 Serious Incident Aircraft



Photograph 2 Damaged Nose Gear

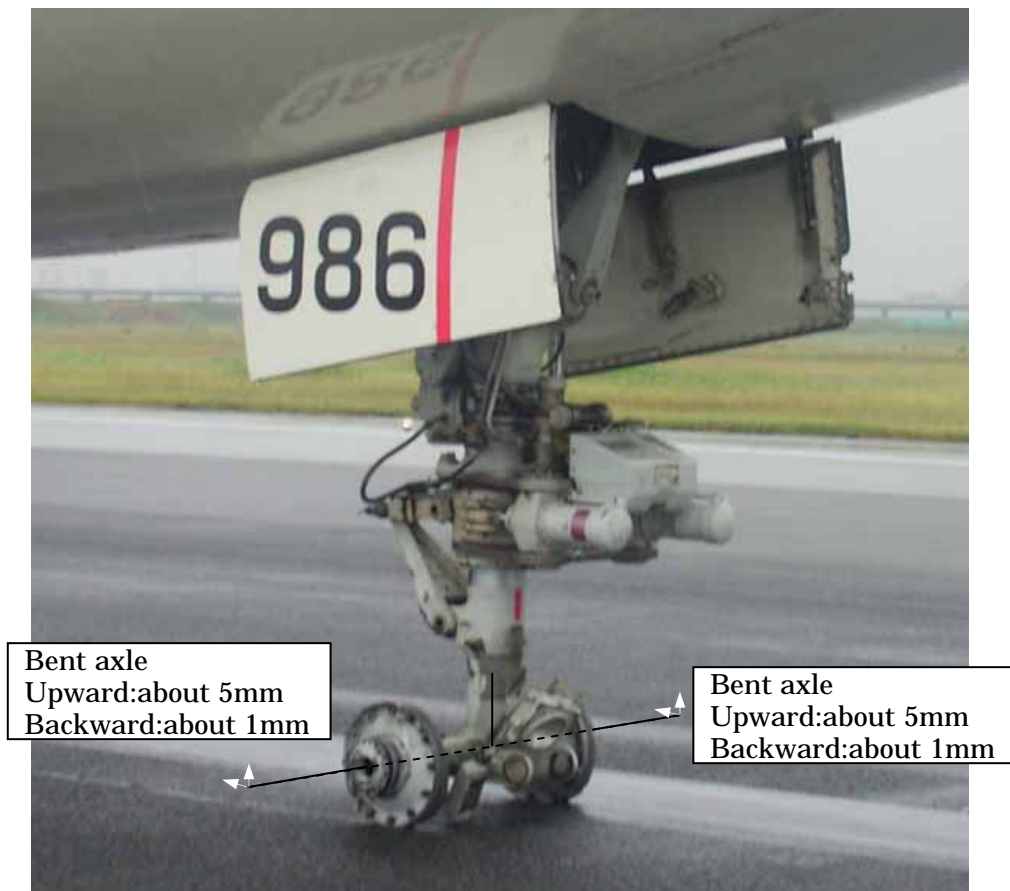

Photograph 3 Removed Both Nose Tires

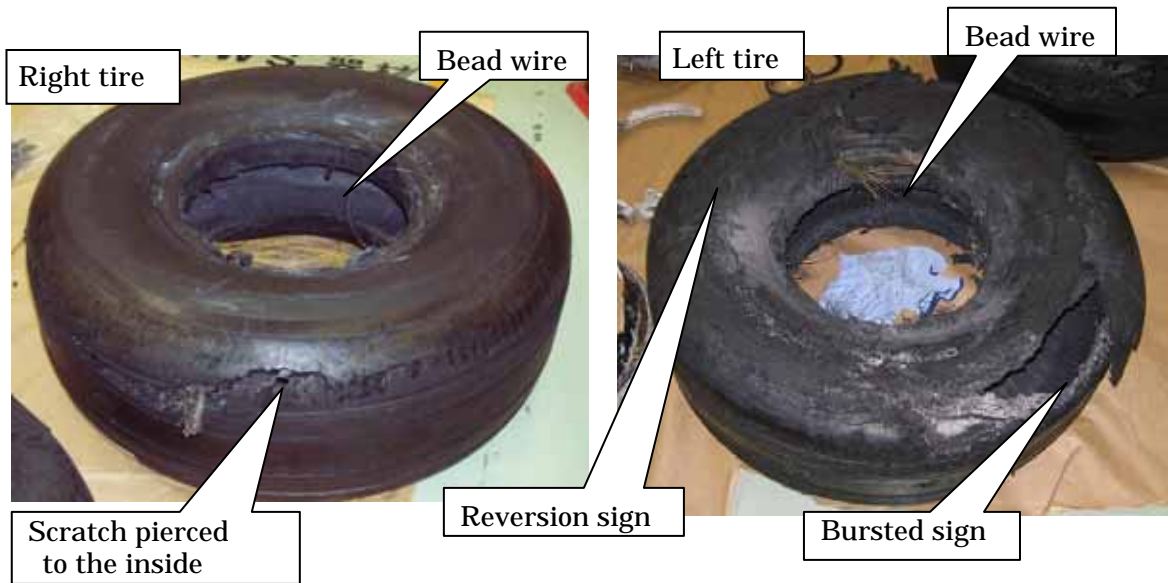

Photograph 4 Cross Section and Names



Photograph 5 Destroyed Nose Wheels

Left wheel outboard



Left wheel



Left wheel inboard



Right wheel inboard



Right wheel



Right wheel outboard



Attachment CVR record

時刻	P F (FO)	P N F (PIC)	AREA MIKE
9:58:32	Stabilized.	Five hundred.	
9:58:39	Check.	Approaching minimum.	
9:58:49	Landing.	Minimum.	
9:58:53	Yes	The heading is just about it.	
9:59:05			One hundred
9:59:09			Fifty
9:59:10			Thirty
9:59:11			Twenty
9:59:12			Ten
9:59:13			Chattering sound
9:59:15			Very loud breaking sound
9:59:19			Rolling sound of hard whells, 5s lasted
9:59:25			Scraping or knocking sound, then, continuous sound rolled by wheels
9:59:30			Sound of knocking something started, intercal became longer.
9:59:31		Speedbrake up	Knockng sound ceased.
9:59:35			Rolling sound of not round objects
9:59:38			
9:59:44	Request stop on the Runway.	Stop...stop... (The end is not clear.)	
9:59:50			Rolling sound ceased.

Note: Bold letters were spoken in Japanese.