

AI2011-3

**AIRCRAFT SERIOUS INCIDENT  
INVESTIGATION REPORT**

**KOREAN AIR**

**H L 7 2 4 0**

**March 25, 2011**

**Japan Transport Safety Board**

The objective of the investigation conducted by the Japan Transport Safety Board in accordance with the Act for Establishment of the Japan Transport Safety Board and with Annex 13 to the Convention on International Civil Aviation is to prevent future accidents and incidents. It is not the purpose of the investigation to apportion blame or liability.

Norihiro Goto  
Chairman,  
Japan Transport Safety Board

Note:

This report is a translation of the Japanese original investigation report. The text in Japanese shall prevail in the interpretation of the report.

**AIRCRAFT SERIOUS INCIDENT  
INVESTIGATION REPORT**

**KOREAN AIR  
AIRBUS INDUSTRY A300B4-600R, HL7240  
AT AN ALTITUDE OF APPROXIMATELY 33,000 FT, OVER THE  
VICINITY OF HIKARI CITY, YAMAGUCHI PREFECTURE,  
JAPAN  
AT ABOUT 19:36 JST, JUNE 23, 2009**

February 25, 2011

Adopted by the Japan Transport Safety Board

Chairman Norihiro Goto

Member Shinsuke Endoh

Member Toshiyuki Ishikawa

Member Sadao Tamura

Member Yuki Shuto

Member Toshiaki Shinagawa

# **1. PROCESS AND PROGRESS OF THE INVESTIGATION**

## **1.1 Summary of the Serious Incident**

The occurrence covered by this report falls under the category of “Abnormal decompression inside an aircraft” as stipulated in Clause 11, Article 166-4 of the Ordinance for Enforcement of the Civil Aeronautics Act of Japan, and is classified as a serious incident.

On June 23 (Tuesday), 2009, at 19:04 Japan Standard Time (JST: UTC+9hr, unless otherwise stated, all times are indicated in JST on a 24-hour clock), an Airbus Industry A300B4-600R, registered HL7240, operated by Korean Air, took off from Jeju International Airport for Chubu Centrair International Airport on a scheduled Flight KAL755 of the company. At about 19:36, while flying at an altitude of approximately 33,000 ft, over the vicinity of Hikari City, Yamaguchi Prefecture, an instrument indicated cabin decompression, so the Pilot in Command (hereinafter referred to as “PIC”) deployed the oxygen masks in the cabin. The PIC requested Air Traffic Controller (hereinafter referred to as “ATC”) for priority and made an emergency descent. The aircraft flew on and, at 20:35, landed at Chubu Centrair International Airport.

There were 164 people on board, consisting of the PIC, the First Officer, eight cabin attendants and 154 passengers. There were no injuries to people nor any damage to the aircraft.

## **1.2 Outline of the Serious Incident Investigation**

### **1.2.1 Investigation Organization**

On June 23, 2009, the Japan Transport Safety Board designated an investigator-in-charge and two other investigators to investigate this serious incident.

### **1.2.2 Representatives from Foreign Authorities**

An accredited representative of Republic of Korea, as the State of Registry and the Operator of the aircraft involved in this serious incident, an accredited representative of France, as the State of Design and Manufacture of the aircraft, and an accredited representative of Canada, as the State that supervised Inspection of components of the aircraft, participated in the investigation.

### **1.2.3 Implementation of the Investigation**

June 24 and 25, 2009	Airframe examination and interviews
June 26, 2009 – July 6, 2009	Analysis of data recorded with digital flight data recorder and cockpit voice recorder
June 27 – 29, 2009	Airframe inspection in the presence of representative from Korean Aircraft and Railway Accident Investigation Board (ARAIB)
July 22, 2009 – August 18, 2009	Aircraft component inspection at Korean Air facilities and others in the presence of ARAIB
August 10 – 21, 2009	Aircraft component inspection at facilities of component maintenance company in Canada in the presence of representative from Transportation Safety Board of Canada (TSB)

January 8, 2010

Comments received from French Bureau of Accident  
Investigation (BEA) on this serious incident

**1.2.4 Comments from Parties Relevant to the Cause of the Serious Incident**

Comments were invited from parties relevant to the cause of this serious incident.

**1.2.5 Comments from the Participating States**

Comments were invited from the participating States.

## 2. FACTUAL INFORMATION

### 2.1 History of the Flight

On June 23, 2009, an Airbus Industry A300B4-600R, registered HL7240 (hereinafter referred to as “the Aircraft”), operated by Korean Air (hereinafter referred to as “the Company”), took off from Jeju International Airport for Chubu Centrair International Airport on a scheduled Flight KAL755 of the Company.

The flight plan for the Aircraft is outlined below:

Flight rules:	Instrument flight rules (IFR)
Departure aerodrome:	Jeju International Airport
Estimated off-block time:	19:00
Cruising speed:	424 kt
Cruising altitude:	FL330
Route:	Iki VOR/DME (IKI) – Fukuoka VORTAC (DGC) – Kuga VORTAC (IWC) – Matsuyama VOR/DME (MPE)
Destination aerodrome:	Chubu Centrair International Airport
Alternate aerodrome:	Kansai International Airport
Total estimated elapsed time:	1 h 26 min
Fuel load expressed in endurance:	2 h 58 min
Persons on board:	156

At the time of the serious incident, in the cockpit of the Aircraft, the PIC was sitting in the left seat as the PF (pilot flying: pilot mainly in charge of flying) and the First Officer was sitting in the right seat as the PM (pilot monitoring: pilot mainly in charge of duties other than flying).

The flight history of the Aircraft from when it took off from Jeju International Airport up to the time of the serious incident is as outlined below according to the records of the digital flight data recorder (hereinafter referred to as “the DFDR”), the ATC communications records and the statements from the flight crewmembers and the cabin attendants of the Aircraft.

#### 2.1.1 Records of the DFDR and ATC communications

19:03:32	The Aircraft took off from Jeju International Airport.
19:14:17	While climbing, the engine anti-ice * <sup>1</sup> valves opened briefly (for about one minute at an altitude of about 27,500 ft).
19:17:00	The Aircraft leveled off at 33,000 ft.
19:35:40	The wing anti-ice * <sup>2</sup> valves opened.

---

\*<sup>1</sup> : The “engine anti-ice” system is used in icing or snowing conditions to prevent the loss of engine performance or damage to the engines by keeping the engine nose cowls warm. The hot air used to prevent icing is taken from the 15<sup>th</sup> stage of the engine compressors.

\*<sup>2</sup> : Of the six slats (leading-edge high-lift systems) on the wings (three on each wing), the “wing anti-ice” system blows hot air onto the outer four slats (two on each wing between the engine and

19:36:43	The No. 1 engine bleed valve * <sup>3</sup> closed.
19:36:52	The No. 2 engine bleed valve closed, turning both No. 1 and No. 2 packs off.
19:38:34	The crew requested approval from the Fukuoka Air Traffic Control Center for emergency descent to 10,000 ft.
About 19:38:40	The Aircraft began an emergency descent (at a rate of about 5,000 ft/min). The oxygen masks were deployed.
19:39:19	The ATC approved the Aircraft to descend to 10,000 ft.
About 19:47:00	The Aircraft leveled off at about 9,400 ft.
About 20:06:10	The Aircraft climbed to about 10,300 ft and leveled off.
About 20:20:20	The Aircraft began descending for landing.
20:34:53	The Aircraft landed at Chubu Centrair International Airport.

## 2.1.2 Statements of the Flight Crewmembers and Cabin Attendants

### (1) PIC

The Aircraft took off from Jeju International Airport at 19:03. While cruising at 33,000 ft, TAT \*<sup>4</sup> stayed below 8°C.

As we encountered clouds, the engine anti-ice was turned on. There was accretion of ice on the wipers and the windshield, so the wing anti-ice was turned on.

Two to three minutes after turning on the wing anti-ice, the message “ENG BLEED 1 FAULT” was displayed on the ECAM \*<sup>5</sup>. While I was taking actions for that message, the ECAM issued a succession of further messages: “ENG BLEED 2 FAULT,” “PACK 1 FAULT” and “PACK 2 FAULT.”

While I was taking actions for these ECAM messages, the cabin altitude \*<sup>6</sup> indicator on the overhead panel showed abnormally high readings. At the same time, I felt dizzy and nauseous, typical symptoms of hypoxia. Therefore, I put on an oxygen mask, checked the secondary display \*<sup>7</sup> for cabin pressure, and realized that the cabin altitude had shot up.

As the outflow valves were fully open, I attempted to manually close them by pushing the outflow valve manual control buttons several times. However, the valves

---

the wing tip) to prevent icing. The hot air used for this purpose is taken from the crossfeed duct of the pneumatic system.

\*<sup>3</sup> : An “engine bleed valve” opens or closes to allow air from the engine compressor to be used elsewhere.

\*<sup>4</sup> : “TAT” stands for total air temperature. Because air at the sensing element of the thermometer is heated by adiabatic compression, the temperature reading is higher than the true temperature of the atmosphere. This temperature is referred to as total air temperature (TAT).

\*<sup>5</sup> : “ECAM,” which stands for electric centralized aircraft monitoring, is a display unit on which a range of information can be accessed as needed. It automatically performs all data processing. The flight crews check the ECAM display and perform the required tasks.

\*<sup>6</sup> : “Cabin altitude” is the altitude in the standard atmosphere corresponding to the cabin pressure.

\*<sup>7</sup> : “Secondary display” refers to the right-hand side ECAM display unit of the two ECAM displays.

did not respond. Neither of us touched the switch for the emergency ram air inlet door \*<sup>8</sup>.

I decided to make an emergency descent. At around Kuga VORTAC (IWC), I made a descent while making a right turn, and at the same time declared an emergency to the Fukuoka Air Traffic Control Center. During the descent, I released the oxygen masks manually for the safety of passengers. In a few minutes after releasing the masks, the cabin altitude warning chime sounded repeatedly, so I cancelled the chime.

After leveling off at 10,000 ft, the cabin altitude display stayed red (the display is red when the cabin altitude is at or above 10,000 ft). Therefore, I made a request to the Fukuoka Air Traffic Control Center for a descent to 9,000 ft. While the ECAM actions and checklist items were being performed during the subsequent descent, all systems returned to normal.

When we were down to 9,000 ft, TAT had risen and there was no ice on the wipers nor on the windshield. So, I turned off all anti-ice buttons.

I contacted the cabin. After checking, I was told that no one was injured.

After consulting with the Company's branch office at Kansai International Airport, it was decided that we would fly on to Chubu Centrair International Airport.

## (2) First Officer

Cabin altitude rose and I felt symptoms of hypoxia. Therefore, I put on an oxygen mask and checked the cabin pressure on the ECAM.

The cabin altitude was abnormally high; it should normally stay at 10,000 ft or lower.

As the PIC noticed that outflow valves were fully open, he attempted to close them manually. However, the valves did not respond. Then, a request for an emergency descent was made to the Fukuoka Control.

Although the master warning chime continuously made a tapping sound, the PIC canceled it as we were in an emergency descent. Normally, when the master warning is activated, a cabin announcement is automatically made. However, there was no such announcement, so the PIC made an announcement himself, saying, "We are in an emergency descent," using the emergency passenger address system (PA: emergency address microphone).

The "BLEED FAULT" and "PACK FAULT" messages were still displayed. I switched the outflow valve operation mode from MANUAL, which the PIC had earlier selected, back to AUTO and checked the cabin altitude, which I remember was roughly 12,500 ft. After leveling off at 10,000 ft, the cabin altitude indication was at around 10,300 – 10,400 ft and still red.

After confirming the minimum safe altitude (MSA), we requested the Fukuoka Air Traffic Control Center for a descent to 9,000 ft. We then descended to 9,000 ft. The cabin altimeter reading then showed normal level. I removed the oxygen mask and found that I felt all right. The PIC then removed his mask.

---

\*<sup>8</sup> : See 2.10 (2) for the description of the "emergency ram air inlet door."



We then proceeded with the ECAM actions and checklist items, which could not be performed earlier. With these actions done, all systems returned to normal.

(3) The statements from the cabin attendants are summarized as follows.

The cabin attendants served dinner at around 19:30. When they were about to start selling duty-free goods at 19:40, the seatbelt sign came on once.

There was an announcement from the PIC, telling the cabin attendants also to take seats. So they stopped selling duty-free goods, stowed away and locked all the carts, ensured everything was safe, and then took seats.

Approximately four cabin attendants felt slightly ill, but they thought it was due to the pitching and rolling of the Aircraft. A cabin attendant attempted to establish contact with the PIC to obtain information on turbulence, but there was no response. Upon trying again soon, she heard tense conversations in the cockpit over the interphone. At the same time, she felt the Aircraft was descending, and just as she thought, "Something is happening," all the oxygen masks were deployed. At that time, the pre-recorded announcement was not automatically made. The cabin attendant tried to contact the cockpit but there was no response. Since the PIC was not picking up the interphone and the oxygen masks had been deployed while the Aircraft was descending, she considered that it was an emergency and called out loud, asking the passengers to wear seatbelts and put on the masks.

After about 10 minutes, the PIC instructed to check the safety of the passengers and cabin attendants. The PIC also said that the Aircraft was now at a safe altitude so the cabin attendants could remove their oxygen masks and go back to normal duties.

The cabin attendants then checked for any injured or otherwise affected persons, fire, or any other abnormalities on the airframe in the entire cabin, galleys and lavatories. A cabin attendant then announced to the passengers that they could now relax and behave normally. However, two passengers were found to be not in good condition.

One passenger had a headache and was feeling "a little dizzy." This passenger was given a portable oxygen bottle and a cabin attendant sat next to him/her. The second passenger had suffered slight burns on his/her fingers after touching a hot part of the oxygen generator. A glass of water and ice was provided to this passenger in which to dip and cool the affected fingers. This passenger said that he/she did not need any adhesive bandage. When these passengers disembarked, they said they were all right and did not need any further care.

Normally, when cabin decompression occurs, the no-smoking and seatbelt signs come on, the oxygen masks are deployed, and a pre-recorded announcement is made. In this serious incident, however, the pre-recorded announcement was not made at the intended timing, but was suddenly made while the passengers were waiting to disembark after the Aircraft had arrived at the spot.

The serious incident occurred at about 19:36, at an altitude of 33,000 ft, over the vicinity of

Hikari City, Yamaguchi Prefecture (Latitude 33°51'18"N, Longitude 131°40'55"E).

(See Figure 1 – The Serious Incident Occurrence Point, Weather Data and Estimated Flight Route; Figure 3-1 – DFDR Records 1; Figure 3-2 – DFDR Records 2; Figure 4 – Air-Conditioning, Pressurization and Ventilation Systems; Figure 5 – Pneumatic System; Figure 6 – Fan Air Valve Control; Photo 1 – The Serious Incident Aircraft; Photo 2 – Anti-Ice Control Panel; Photo 3 – R/H ECAM Display; Photo 4 – Cabin Pressure Control Panel; Photo 5 – Air Bleed Control Panel; Photo 6 – Cabin Oxygen Mask Drop; Photo 7 – Cabin Oxygen Generation Equipment; Photo 8 – Fan Air Valve; Attachment – ATC Communication Records)

## 2.2 Injuries to Persons

No one was injured.

## 2.3 Damage to the Aircraft

There was no damage to the Aircraft.

## 2.4 Personnel Information

(1) PIC Male, Age 41

Airline transport pilot certificate (Airplane)	July 20, 2006
Type rating for Airbus Industry A300-600	
Class 1 aviation medical certificate	
Validity	December 31, 2009
Total flight time	6,292 h 00 min
Flight time in the last 30 days	18 h 00 min
Total flight time on the type of aircraft	1,528 h 00 min
Flight time in the last 30 days	18 h 00 min

(2) First Officer Male, Age 32

Commercial pilot certificate (Airplane)	December 1, 2006
Type rating for Airbus Industry A300-600	
Class 1 aviation medical certificate	
Validity	May 31, 2010
Total flight time	906 h 00 min
Flight time in the last 30 days	43 h 00 min
Total flight time on the type of aircraft	557 h 00 min
Flight time in the last 30 days	43 h 00 min

## 2.5 Aircraft Information

### 2.5.1 Aircraft

Type	Airbus Industry A300B4-600R
Serial number	631
Date of manufacture	February 26, 1992
Certificate of airworthiness	AS05024
Validity	Indefinite Date
Total flight time	33,883 h 25 min
Flight time since last periodical check (C check on July 23, 2008)	1,196 h 40 min

(See Figure 2 – Three Angle Views of Airbus Industry A300B4-600R)

## 2.5.2 Engines

### (1) Left engine

Type	Pratt & Whitney PW41583
Serial number	P724872CN
Date of manufacture	September 4, 1993
Total time in service	24,419 h 25 min
Total cycles * <sup>9</sup>	26,216

### (2) Right engine

Type	Pratt & Whitney PW41583
Serial number	P724086CN
Date of manufacture	January 28, 1991
Total time in service	27,544 h 25 min
Total cycles	23,897

## 2.5.3 Inspection of the Cabin Pressurization System at Chubu Centrair International Airport

Inspection of the cabin pressurization system, carried out as part of the airframe examination at Chubu Centrair International Airport, found no abnormalities.

## 2.5.4 Results of the Airframe Inspection and Related Activities in Republic of Korea

With the Aircraft was ferried to Republic of Korea, the Company conducted an airframe inspection and related activities on the Aircraft. These activities and the results are summarized below.

### (1) Test on the No. 1 and No. 2 pneumatic controllers

#### (a) Detection of "ENG BLEED 1 FAULT"

"FAN AIR VALVE" error found stored in the memory (No. 1)

#### (b) Detection of "ENG BLEED 2 FAULT"

"CONTROLLER" error found stored in the memory (No. 2)

### (2) Replacement of the R/H wing anti-ice valves (alternate)

- "OPEN" signals recorded on the DFDR

### (3) Inspection of the cabin pressurization system

\* With the cabin pressurized, the outflow valves were inspected.

- The repeated auto/manual control system inspection found no abnormalities.

- The cabin pressure controller BITE test found no abnormalities.

### (4) Replacement of the crossfeed valve

- Although no error had been detected, the valve was replaced at the request of the flight crew.

### (5) Replacement of the No. 1 bleed temp. control sensor

---

\*<sup>9</sup> : In this report, one "cycle" consists of a pair of takeoff and landing.

- The sensor wiring test found rather high resistance readings ( $87\Omega/78-90\Omega$ ), although these are still within the permissible range. It had no influence on the serious incident.
- (6) Restoration of the cabin oxygen supply system
    - As “AUTO ANNOUNCEMENT SOMETIMES” was displayed in a BITE check, the programmed announce reproducer was replaced.
  - (7) Flight test
    - June 27, 2009: All normal
    - June 28, 2009: Maintenance engineer on-board checklist items were all normal.
  - (8) Planned preventive maintenance
    - To identify the causes of the displays of the faulty No. 1 fan air valve and faulty No. 2 pneumatic controller (“ENG BLEED 1 FAULT” and “ENG BLEED 2 FAULT”), the Company sent the No. 1 fan air valve and the No 2 pneumatic controller to its repair facilities.

### **2.5.5 Fuel and Lubricating Oil**

The fuel used in the Aircraft was aviation fuel Jet A-1. The lubricating oil was MOBIL JET OIL 2.

### **2.6 Meteorological Information**

The general weather forecasts for Yamaguchi Prefecture issued by the Shimonoseki local meteorological observatory at 16:50 on the day the serious incident occurred was as follows.

“Due to a seasonal rain front, it is cloudy in most of Yamaguchi Prefecture, and is raining in some areas.

Due to the rain front and depression, the weather during the night of June 23 will be cloudy, with some areas expecting rain.”

The general weather forecasts for Ehime Prefecture issued by the Matsuyama local meteorological observatory at 16:33 on the day the serious incident occurred was as follows.

“A seasonal rain front is moving north, bringing clouds to an increasing number of areas in Ehime Prefecture, and rain in parts of the prefecture. On June 23, the rain front will intensify and bring thunderstorms, and the rain will become heavier later in the night.”

(See Figure 1 – The Serious Incident Occurrence Point, Weather Data and Estimated Flight Route)

### **2.7 Information on DFDR and Cockpit Voice Recorder**

The Aircraft was equipped with a DFDR (part number: 980-4700-042) and a cockpit voice recorder (CVR) (part number: 980-6005-076), both made by Honeywell of the United States of America.

The DFDR retained data relevant to the serious incident.

The CVR, capable of recording for a period of about 30 minutes, did not retain data for the time around when the serious incident occurred because the data was overwritten.

The time was determined by correlating the DFDR recorded VHF transmission keying signals with the Nippon Telegraph and Telephone Corporation speaking clock recorded on the ATC communication records.

## 2.8 Outline of the Air Conditioning and Related Systems of the Aircraft

- (1) The Aircraft's air conditioning and cabin pressurization systems are designed to maintain the cabin pressure and temperature at preferred levels while providing ventilation. Air to be used by the systems and others is bled from the engines and, after adjustment to the preferred temperature, is distributed via the AC pack system to the cabin, and then it is discharged out of the Aircraft via the outflow valves. Cabin pressure is automatically controlled by adjusting the opening of the outflow valves.
- (2) The AC pack system consists of a compressor, a turbine, a heat exchanger and other components. The flow rate and temperature of the bleed air are adjusted here before it is sent to the pressurized cabin.

## 2.9 Bleed Air Control

- (1) Fan air, cold air bled from the engine fan, flows via the fan air valve into the pre-cooler <sup>\*10</sup>. Engine bleed air, hot air bled from the 8<sup>th</sup> and 15<sup>th</sup> stage of the engine compressor, flows via the bleed valve and others and joins the fan air at the pre-cooler.
- (2) According to the A300-600 aircraft maintenance manual (AMM) issued by the manufacturer of the Aircraft, the temperature of the pre-cooler is controlled by adjusting the opening of the fan air valve, thereby adjusting the flow rate of the cold air. This control is managed by the pneumatic controller based on signals from the temp. control sensor downstream of the pre-cooler. Normally, the opening of the fan air valve is adjusted so that the temperature of the pre-cooler outlet is maintained at  $177 \pm 12^{\circ}\text{C}$ . When bleed air from one of the engines ceases to be supplied or the wing anti-ice switch is set to ON (hereinafter referred to as "temperature shift"), the temperature of the pre-cooler outlet is adjusted to  $227 \pm 12^{\circ}\text{C}$ . At the time of temperature shift, the pneumatic controller adjusts the opening of the fan air valve to provide higher temperature. In addition, the pre-cooler has an overheat detection function, which closes the bleed valve of the relevant system when the outlet temperature reaches  $207 \pm 3^{\circ}\text{C}$  in normal operation or  $255 \pm 3^{\circ}\text{C}$  in temperature shift. After the pre-cooler, the air adjusted as described above is sent to the AC pack (air cycle machine) system, the anti-ice system and other components. (See Figure 4 - Air-Conditioning, Pressurization and Ventilation Systems; Figure 5 – Pneumatic System)
- (3) If a fault occurs in the fan air valve or in the pneumatic controller, the engine bleed valve

---

<sup>\*10</sup> : The "pre-cooler" mixes cold fan air and hot compressor air from the engine and, after temperature adjustment, sends the mixture to the AC pack and wing anti-ice systems.

will be closed, shutting off air supply to the AC pack, wing anti-ice and other systems, making these systems inoperative.  
(See Figure 6 – Fan Air Valve Control)

## 2.10 Maintenance Manual Descriptions of Cabin Pressurization Control and others

The A300-600 aircraft maintenance manual (AMM) is summarized as follows.

- (1) The cabin pressurization system is fully automatic and electrically operated. It consists of two independent sub-systems, and operates two outflow valves.

One of the outflow valves is located fore of an air conditioning area while the other valve is located aft of the cargo compartment. Each valve is driven by one of three motors. The three motors are separately controlled by two automatic systems and one manual system. The manual system is controlled by a toggle switch on the overhead panel in the cockpit. If one of the two automatic systems becomes faulty, the control is automatically switched to the other. Regardless of whether or not the two automatic systems are faulty or not, the manual system can be controlled using the cockpit toggle switch to open or close the outflow valves.

The cabin pressure controller automatically controls the cabin pressurization system, pressurizing or depressurizing the cabin, based on the cabin altitude, aircraft altitude and others.

- (2) The emergency ram air inlet system is used only when flying at low altitude without pressure difference. If the air-conditioning system becomes inoperative, the system lets outside air into the aircraft for cabin ventilation. When the system is activated, it opens the ram air inlet door to take in the outside air, while at the same time the cabin pressure controller fully opens the outflow valves as an outlet for cabin air.

(See Figure 4 – Air-Conditioning, Pressurization and Ventilation Systems)

## 2.11 Status Changes of Relevant Systems

Operations of the relevant systems as indicated by the DFDR records are summarized as follows.

19:03:32	The Aircraft took off from Jeju International Airport.
19:14:17	While climbing, the No. 1 and No. 2 engine anti-ice valves opened (at about 27,500 ft, for about one minute).
19:15:11	The No. 1 engine anti-ice valve closed.
19:15:13	The No. 2 engine anti-ice valve closed.
19:31:35	The No. 1 engine anti-ice valve opened.
19:31:37	The No. 2 engine anti-ice valve opened.
19:35:40	The RH/LH wing anti-ice valves opened.
19:36:43	The No. 1 engine bleed valve closed.
19:36:48	The LH wing anti-ice valve closed.
19:36:52	The No. 2 engine bleed valve closed. (It is considered highly probable that this moment was the beginning of the serious incident.)
19:36:56	The RH wing anti-ice valve closed.
19:37:02	The crossfeed valve opened.



About 19:38:40	The Aircraft started an emergency descent.
19:46:55	The No. 1 and No. 2 engine anti-ice valves closed.
About 19:47:00	The Aircraft leveled off at about 9,400 ft.
19:52:47	The No. 1 engine bleed valve opened.
19:52:48	The No. 2 engine bleed valve opened.
19:53:18	The crossfeed valve closed.
About 20:06:10	The Aircraft climbed to about 10,000 ft.
20:34:53	The Aircraft landed at Chubu Centrair International Airport.

## 2.12 Detailed Inspections of the Relevant Components

From July 22 through August 18, 2009, the following components were inspected at the Company's facilities and others in the presence of an ARAIB investigator: the No. 1 fan air valve, the No. 1 bleed temp. control sensor, the crossfeed valve, the programmed announce reproducer, and the R/H wing anti-ice valve. In addition, from August 10 through 21, 2009, the Aircraft's No. 2 pneumatic controller was inspected at the facility of a component maintenance company in Canada in the presence of a TSB investigator. The results were as follows.

### (1) No. 1 fan air valve

History: The fan air valve was manufactured by Garret Pneumatic System Division (formerly Honeywell) and was purchased by the Company in March 1988. The fan air valve was operated for 3,103 hours since the last repair at the factory. The total hours of operation were 36,380 hours.

Date of installation: December 11, 2007

- ① There was no external damage to the receptacle pins.
- ② The valve position light on the control box did not illuminate when the fan air valve butterfly was moved from the "close position" to the "open position."
- ③ Continuity test on the position switch revealed intermittent loss of continuity at Pin C \*<sup>11</sup>.
- ④ When the compound was removed from the connector, a slight gap was found in the weld of Pin C.
- ⑤ There were traces of arcing caused by the poor weld of Pin C.

Based on the above, it was determined that poor continuity caused by the poor weld of Pin C contributed to the display of the "BLEED FAULT" message in the cockpit.

(See Photo 8 – Fan Air Valve)

### (2) No. 2 pneumatic controller

History: Installed on May 19, 1992 (delivered as installed on the Aircraft)

Hours of operation since last inspection (TSI): 33,891 hours

- ① The output lamp on test revealed a fault in the bleed fault lamp switch.
- ② The controller fault lamp on test revealed a failure in Position 11 (fan air valve

---

\*<sup>11</sup> : "Pin C" is linked to the open/close switch position of the fan air valve.

position).

- (3) No. 1 bleed temp. control sensor  
While there was no external damage, a functional test found an open circuit.
- (4) Programmed announce reproducer  
Inspection revealed poor soldering of a cabin announcement-related relay on the system control board, which made the key lines occasionally inoperative, preventing the emergency announcement from being heard in the cabin.
- (5) Crossfeed valve (Pneumatic system isolation valve)  
A functional test found no faults.
- (6) R/H wing anti-ice valve  
While a teardown inspection found carbon deposit and poor switching function, it was considered probable that the valve had continued to function, albeit at a low level.  
Technical instructions (SB) (3289614-30-1051: Replacement of piston ring to improve valve function; 3289614-30-1070: Replacement of poppet to prevent sticking) had been issued for the valves by the manufacturer of the Aircraft, but these were optional and were not carried out on the valves of the Aircraft.

## **2.13 Maintenance History of the Aircraft**

### **2.13.1 History of Checks Conducted by the Company**

- (1) A check (every 400 FH): Conducted on June 16, 2009 (33,840 FH)
- (2) C check (every 15 M): Conducted on October 19, 2008 (32,687 FH)
- (3) 5-year check (every 5 Y): Conducted on March 23, 2006
- (4) 3,000-cycle check (every 3,000 FC): Conducted on October 19, 2008 (26,397 FC)

### **2.13.2 Descriptions in the A300-600 Maintenance Planning Document from the Manufacturer of the Aircraft**

- (1) Cabin pressurization system
  - ① PRESSURIZATION CONTROL; 1A (500FH/4M)  
OPERATIONAL CHECK OF CABIN PRESSURE CONTROL  
USING "SYS TEST-OK" FACILITY ON LATERAL PANEL
  - ② CABIN PRESSURE OUTFLOW VALVE; 1C (5,000FH/24M)
    - REMOVE CABIN PRESSURE OUTFLOW VALVES
    - CLEAN VALVE SEAT AND BUTTERFLY
    - REINSTALL OUTFLOW VALVES
  - ③ PRESSURIZATION CONTROL; 1C (5,000FH/24M)  
CHECK EACH CABIN PRESSURE SAFETY VALVE RACK POSITION  
INDICATOR: EXTENDING  
(INDICATOR BLACK BAND FACING THE "OPEN" MARK ON  
TRANSPARENT COVER)

- ④ PRESSURIZATION CONTROL; 2C (10,000FH/48M)  
REMOVE CABIN PRESSURE SAFETY VALVES FOR FUNCTIONAL CHECK  
IN SHOP.
  - ⑤ PRESSURIZATION CONTROL; 2C (10,000FH/48M)  
OPERATIONAL CHECK OF SAFETY VALVES OPENING INDICATION
  - ⑥ RESIDUAL CABIN PRESSURE WARNING; 1C (5,000FH/24M)
    - OPERATIONAL CHECK OF RESIDUAL CABIN PRESSURE WARNING  
SYSTEM
    - FUNCTIONAL CHECK OF THE PRESSURE SWITCH OF THE RESIDUAL  
CABIN PRESSURE WARNING SYSTEM.
- (2) Wing anti-ice system
- ① WING ANTI ICE; 1C (5,000FH/24M)
    - WING ANTIICE "VALVE TEST" USING APU BLEED AIR SUPPLY
    - WING ANTIICE "VALVE TEST" IN "NORM" AND "ALTN" MODES, USING  
ENGINE BLEED AIR SUPPLY OR AN HP GROUND PNEUMATIC SOURCE
    - OPERATIONAL CHECK OF WING ANTIICE "FAULT" WARNING  
INCLUDING EACH INDIVIDUAL "VALVE FAULT"
- (3) Programmed announce reproducer
- ① PASSENGER OXYGEN SYSTEM; 2C (10,000FH/48M)
    - FUNCTIONAL CHECK OF AUTOMATIC RELEASE OF PASSENGER  
OXYGEN MASKS
    - DETAILED INSPECTION OF MASKS, GENERATORS AND RELEASE  
CATCHES
  - ② OPERATION CHECK OF AUTO ANNOUNCEMENT IN CABIN  
KE Requirement; PRE/POST FLIGHT

### **2.13.3 Frequency of Aircraft Maintenance by the Company**

As described in 2.13.1 and 2.13.2, the Company conducted the Aircraft maintenance items specified by the manufacturer of the Aircraft, at shorter intervals than specified by the manufacturer.

### **2.14 Additional Information**

The manufacturer of the Aircraft has provided the following comments on the serious incident.

(Excerpts)

#### *«Conclusions»*

- (1) *During flight from CJU to NGO, KAL A300-600R MSN 631 experienced a cabin depressurization due to the loss of both bleed systems.*
- (2) *Bleed #1 was lost first while the A/C was cruising at FL330 with Engine Anti-Ice on and*

*Wing Anti-Ice on and in abnormally high temperature conditions (recorded temperatures up to ISA\*<sup>12</sup> +19 °C during the flight period when both bleed systems were lost).*

- (3) The root cause for Bleed #1 loss is either an intermittent failure at Fan Air Valve (FAV) connector level, possible failure mode identified during FAV 1 investigations, or a FAV failure to achieve the pre-cooler demand.*
- (4) The crew reported having applied the relevant procedures, but Bleed #2 was lost due to over temperature before procedures could be completed.*
- (5) The crew reported having identified at least one Outflow Valve (OFV) fully open, and then tried to manually control it without success.  
The Airbus analysis does not confirm that any OFV was fully open during the depressurization event.*
- (6) The crew performed an emergency descent and manually deployed the passenger oxygen masks.*
- (7) The EXCESS CAB ALT warning triggered during the emergency descent.*
- (8) The aircraft leveled off at 9,350 ft and the crew continued to apply the ECAM procedures. At that time, both Engine Anti-Ice and Wing Anti-Ice were off.*
- (9) The two bleed systems and the automatic cabin pressure control recovered.*
- (10) The crew elected to continue the flight to NGO and the flight was then uneventful.*

The manufacturer of the Aircraft also commented that, although the cabin pressure usually rises at a rate of 23,250 ft/min if the air-conditioning system is inoperative and one of the outflow valves is fully open, the cabin pressure rose only at a moderate rate of about 1,000 ft/min in the case of the Aircraft.

The manufacturer of the Aircraft also commented that, with the outflow valves fully closed and with no air supply, the natural air leakage from the cabin increases the cabin altitude at a rate of 2,000 ft/min.

The Aircraft Maintenance Manual (AMM) for the Aircraft describes that a warning system is activated at a cabin altitude of 9,950 ft and oxygen masks are automatically released at a cabin altitude of 13,500 – 14,000 ft.

---

\*<sup>12</sup> : “ISA,” or International Standard Atmosphere, is an international standard of atmosphere.

### **3. ANALYSIS**

#### **3.1 Crew Qualifications**

The PIC and the First Officer held both valid airman competence certificates and valid aviation medical certificates.

#### **3.2 Airworthiness Certificate of the Aircraft**

The Aircraft had a valid airworthiness certificate and had been maintained and inspected as prescribed.

As described in 2.13.3, the Company had conducted the required maintenance items on the Aircraft at shorter intervals than specified by the manufacturer.

#### **3.3 Meteorological Conditions**

While the weather conditions at the time of the serious incident required the use of both the engine anti-ice and wing anti-ice, it is considered highly probable that the weather conditions had no direct effect on the occurrence of the serious incident.

#### **3.4 Occurrence Time of the Serious Incident**

As described in 2.1.1, the No. 2 engine bleed valve closed at 19:36:52 soon after the wing anti-ice system was turned on. The DFDR records show that this triggered a chain of faults. It is therefore considered highly probable that the serious incident occurred at around that time.

#### **3.5 Abnormal Cabin Altitude, etc.**

- (1) The “ENG BLEED 1 FAULT” message was displayed on the ECAM soon after the wing anti-ice system was turned on. As described in 2.12, poor welding was found on a connector pin of the No. 1 fan air valve. It is therefore considered highly probable that this poor welding caused the failure of the temperature shift function, which would have changed the temperature setting of the pre-cooler outlet from 177°C to 227°C when the wing anti-ice system was turned on, making the No. 1 engine bleed valve closed, and resulted in displaying of the message on the ECAM. At the same time, as the manufacturer of the Aircraft stated in 2.14 (4), it is considered somewhat likely that the bleed valve closed as a result of detection of overheating.
- (2) It is considered highly probable that the reason why the “ENG BLEED 2 FAULT” message was displayed on the ECAM is, as suggested by the inspection results in 2.12, that the failure of the No. 2 pneumatic controller on temperature shift made the No. 2 engine bleed valve closed. At the same time, as the manufacturer of the Aircraft stated in 2.14 (4), it is considered somewhat likely that the bleed valve closed as a result of detection of overheating.
- (3) It is considered highly probable that the reason why the “PACK 1 FAULT” and “PACK 2 FAULT” messages were displayed on the ECAM is that the No. 1 and No. 2 engine bleed

valves closed, shutting off the supply of pneumatic air to the AC pack system, disabling the two AC packs.

- (4) It is considered highly probable that, as a result of both AC packs having been disabled, cabin pressure could not be maintained, leading to cabin depressurization.  
(See Explanation Diagram – The Incident Occurrence Progress)
- (5) Judging from the statement of the PIC and the DFDR records, it is considered highly probable that, around the time when the Aircraft leveled off at 9,400 ft following an emergency descent, the wing anti-ice system was automatically turned off and the engine anti-ice system was turned off by the crew. It is considered probable that, about five minutes later the bleed valves opened, then the temperature shift function, the pneumatic controller, the AC packs and the cabin pressurization system successively returned to normal.
- (6) It is considered highly probable that the reason why the pre-recorded emergency cabin announcement of depressurization was not made automatically at the time of the serious incident is that the poor soldering in the related electrical circuit as described in 2.12 (4) caused a temporary disruption of continuity.
- (7) In the light of the above, it is desirable that the manufacturer of the Aircraft review the quality of and the current maintenance program (intervals and contents) for the cabin pressurization and automatic emergency announcement systems.

### **3.6 Outflow Valves**

It is considered highly probable that the cabin depressurization occurred as a result of both bleed valves having closed, bringing the two AC systems to a stop as described in 3.5.

As described in 2.1.2, both the PIC and the First Officer stated that the outflow valves were indicated as fully open during the excessive cabin altitude. On the other hand, as described in 2.14, the manufacturer of the Aircraft stated that it could not verify whether any of the outflow valves were fully open, citing the moderate rising rate of cabin altitude.

The DFDR did not record the cabin altitude, and therefore the related details are unclear. However, considering the circumstances at the time of the serious incident including that the oxygen masks were not automatically released, it is considered somewhat likely that the outflow valves did not fully open.

The outflow valves are designed to open fully upon pressing the emergency ram air inlet door switch in the cockpit. As described in 2.1.2, the PIC and the First Officer stated that they did not touch the switch.

At the time of the serious incident, there was a substantial difference in pressure between the cabin and outside of the Aircraft, which did not satisfy the conditions for using the emergency ram air inlet system. In addition, the switch is hidden by a guard to prevent inadvertent activation. It is therefore considered highly probable that there is low possibility that a crew member pressed the switch.

At around the time when the Aircraft leveled off at about 9,400 ft following an emergency

descent, the Aircraft's cabin pressurization system returned to normal. Subsequent inspections at Chubu Centrair International Airport and in Korea found no faults in the open/close control system of the outflow valves. The cause of the full-open display of the outflow valves could not be ascertained.

#### **4. PROBABLE CAUSES**

In this serious incident, it is considered highly probable that the cabin depressurization of the Aircraft that occurred while cruising at about 33,000 ft was caused by the stoppage of both AC systems.

It is considered highly probable that the two AC systems stopped functioning as the failures of the No. 1 fan air valve and the No. 2 pneumatic controller lead to closure of both engine bleed valves.



## **5. ACTIONS TAKEN**

The manufacturer of the Aircraft launched an additional review of Reproducer that host the automatic emergency announcement function, upon receipt of our draft report. (Related to 3.5.(7))

Figure 1 The Serious Incident Occurrence Point,  
Weather Data and Estimated Flight Route

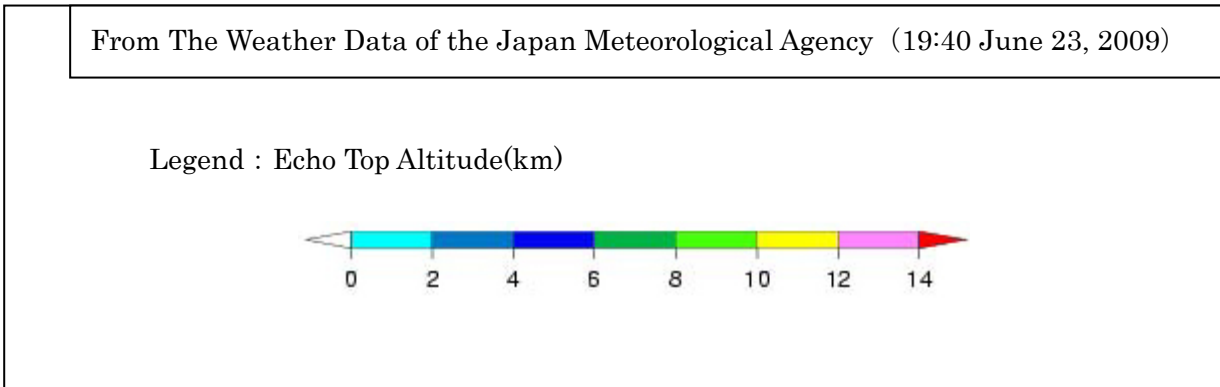
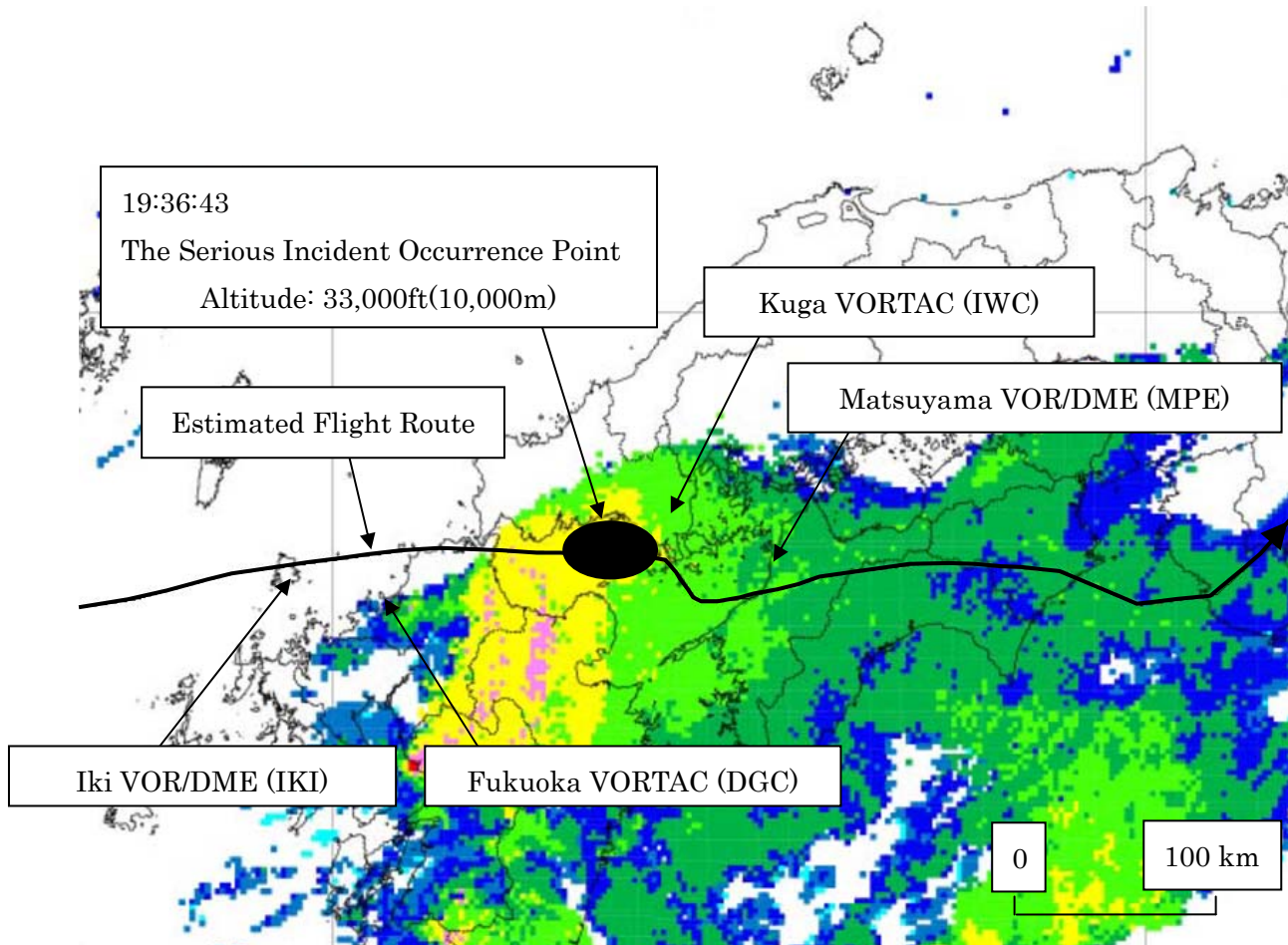

Figure 2 Tree Angle Views of Airbus Industry  
A 3 0 0 B 4 - 6 0 0 R

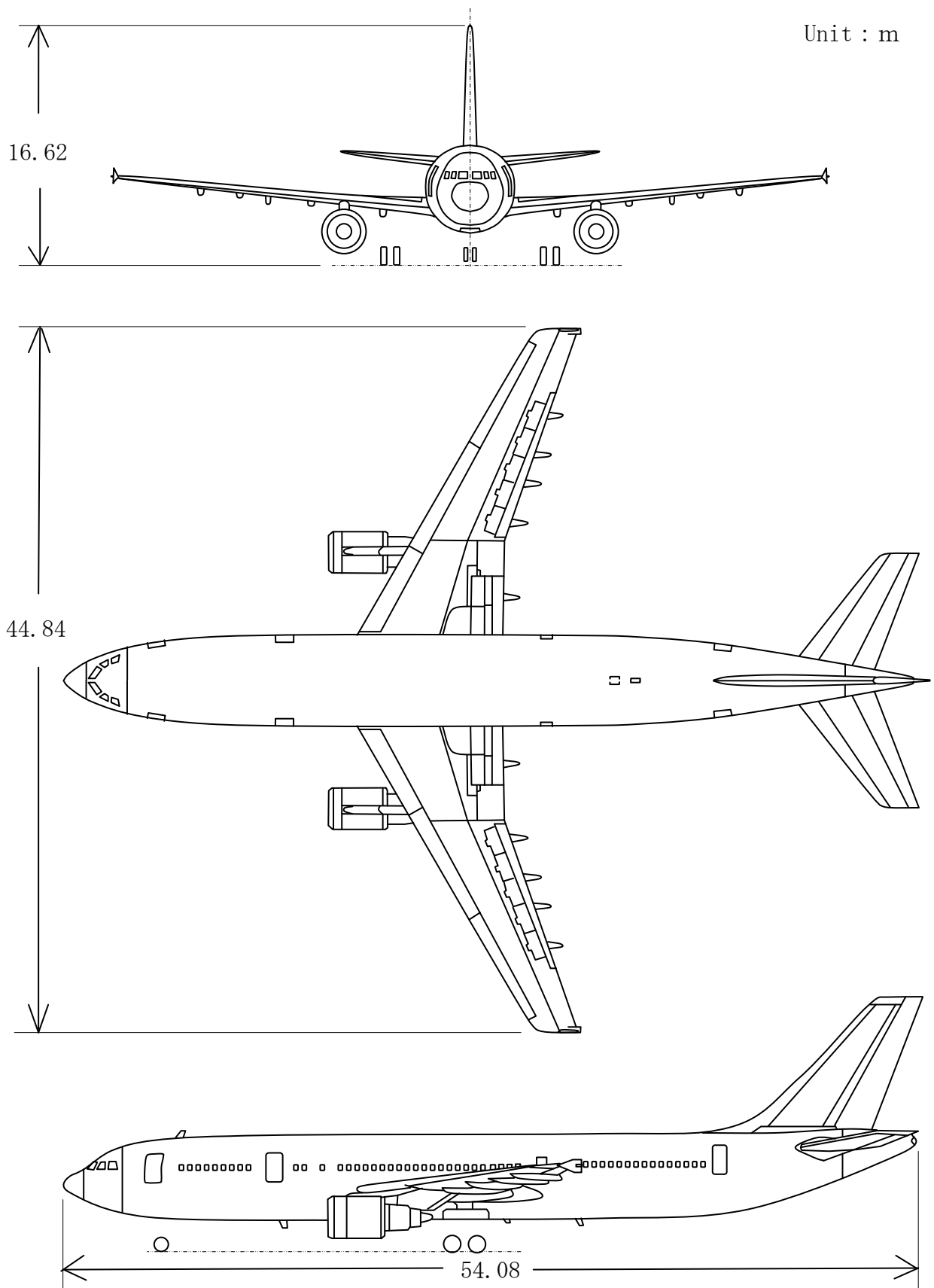

Figure 3 – 1 DFDR Records 1

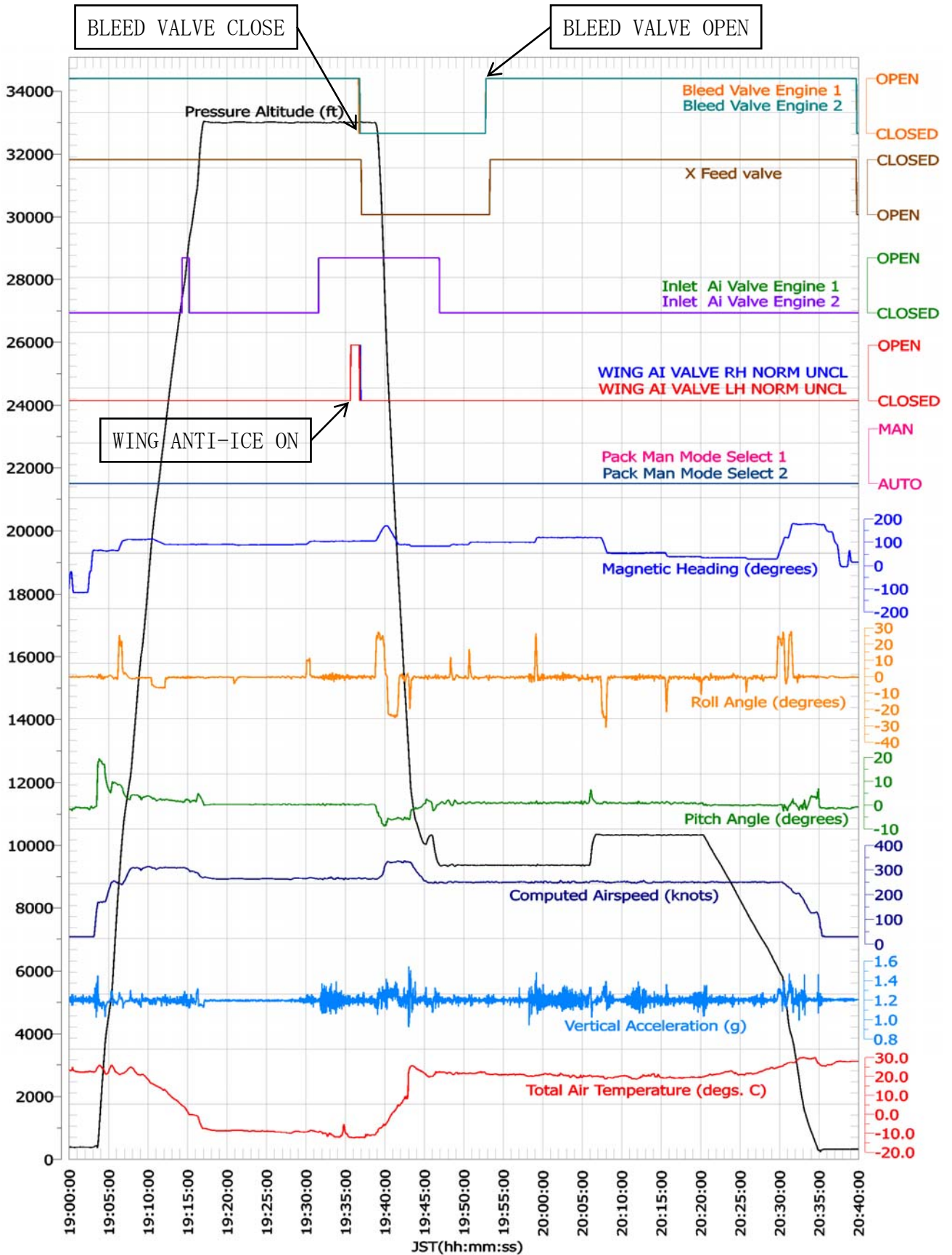

Figure 3 – 2 DFDR Records 2

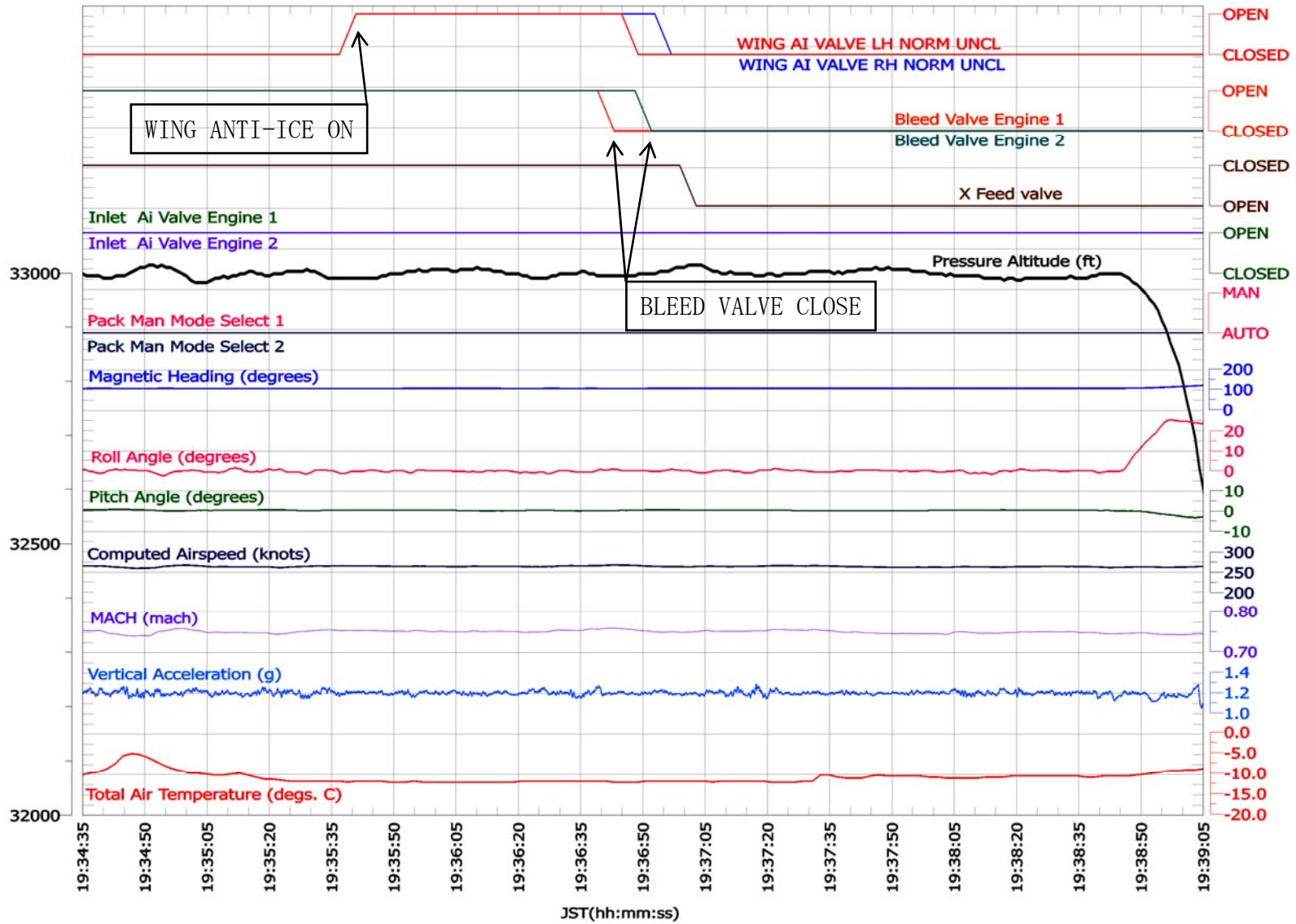
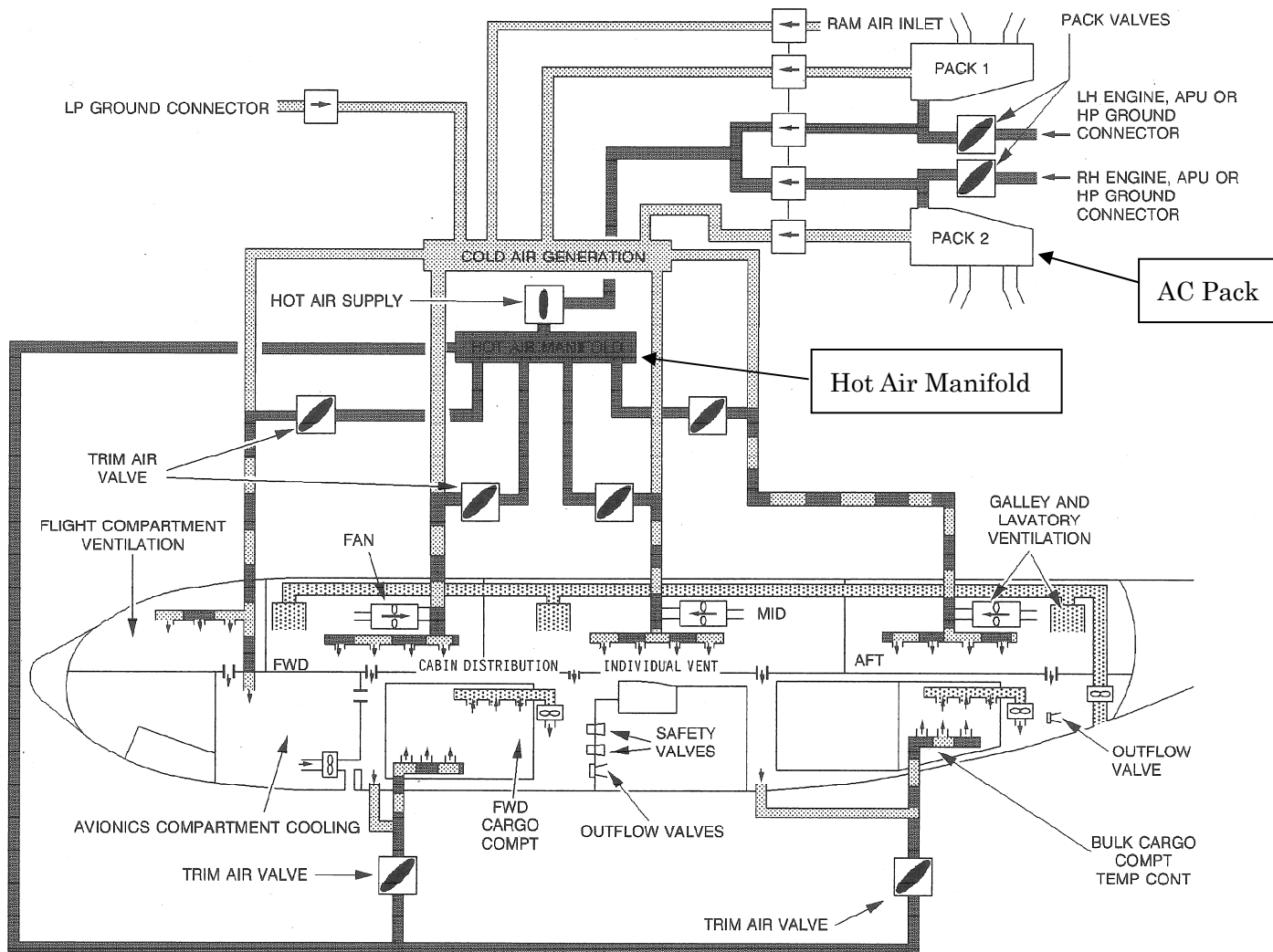
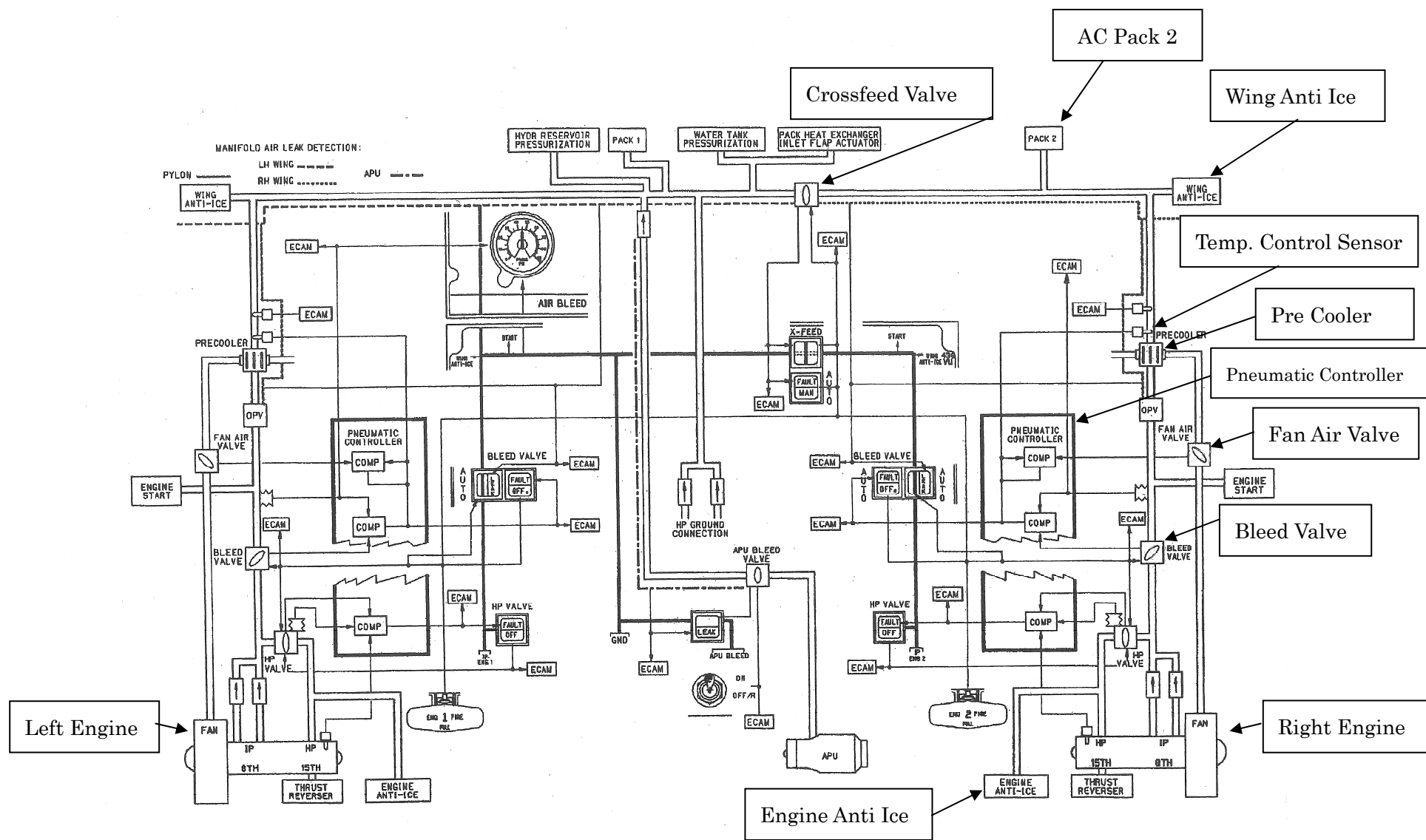

Figure 4 Air-Conditioning, Pressurization and Ventilation Systems



From Aircraft Manufacturer's Training Manual

Figure 5 Pneumatic System



From Aircraft Manufacturer's Operation Manual

Figure 6 Fan Air Valve Control

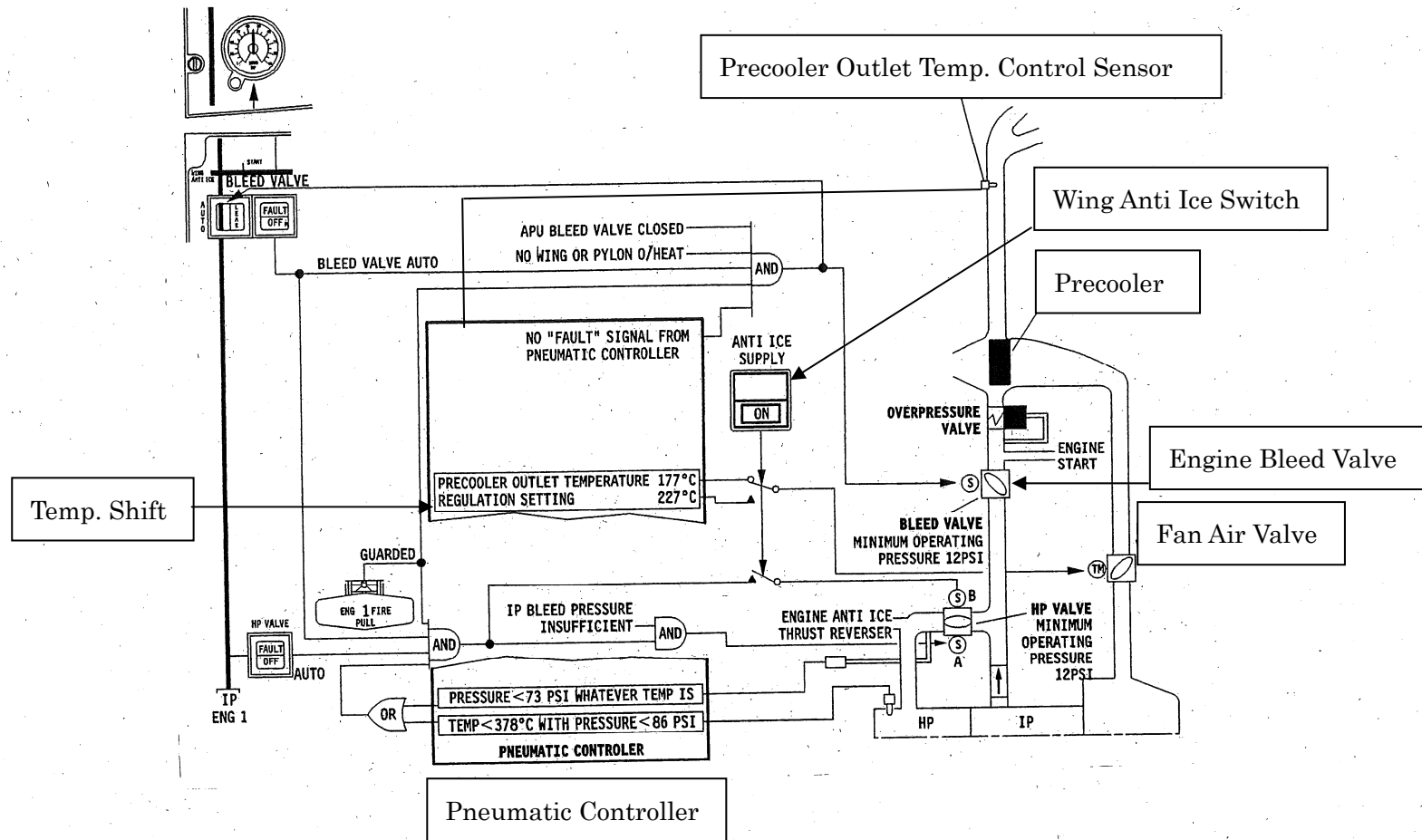

Temp. Shift by Pneumatic Controller :

- When Wing Anti Ice OFF :  $177 \pm 12^{\circ}\text{C}$
- When Wing Anti Ice ON or Air Bleed One system OFF :  $227 \pm 12^{\circ}\text{C}$



Photo1 The Serious Incident Aircraft



Photo2 Anti Ice Control Panel

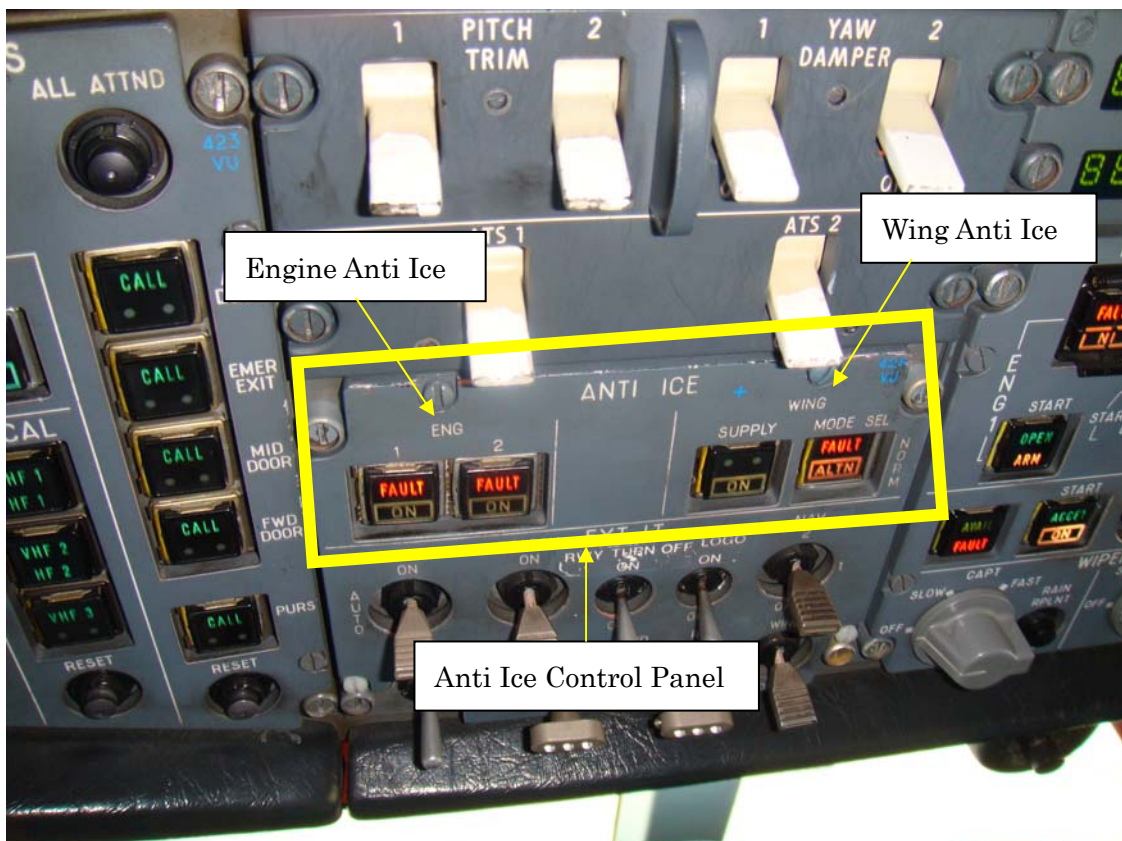

Photo 3 R/H ECAM Display

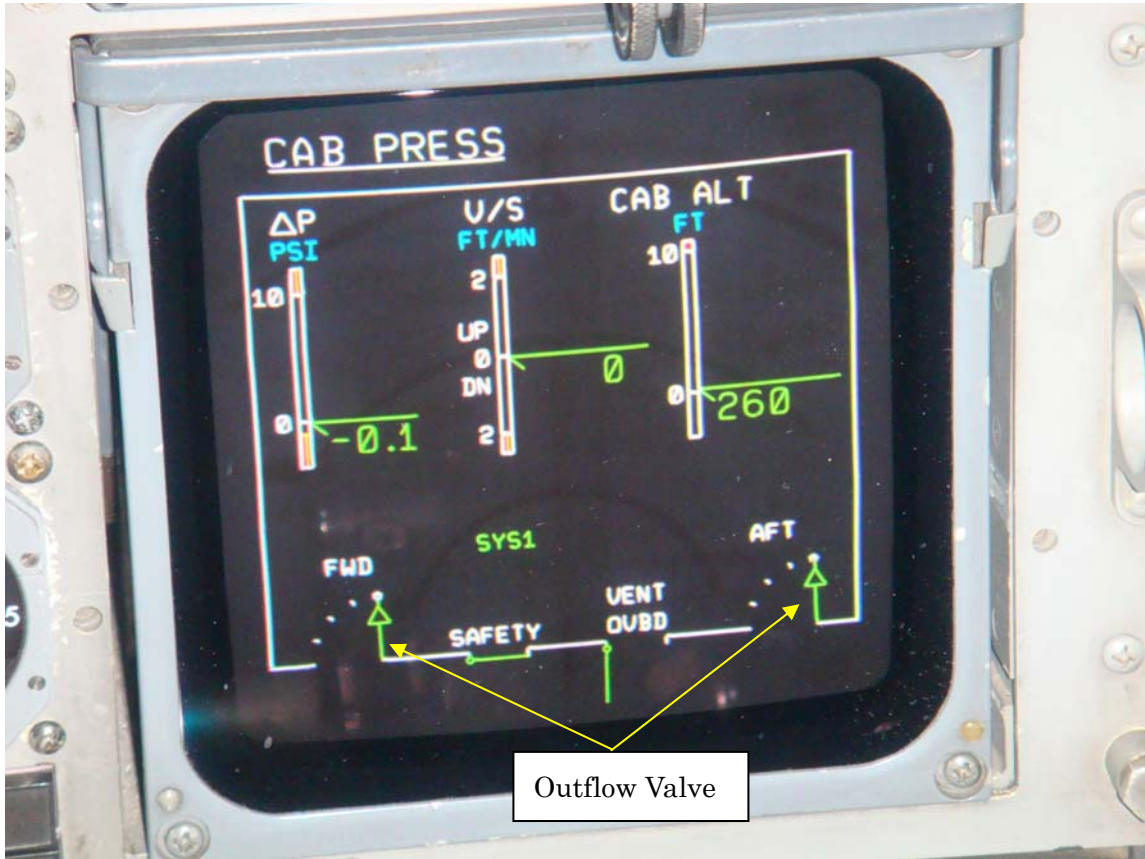

Photo 4 Cabin Pressure Control Panel

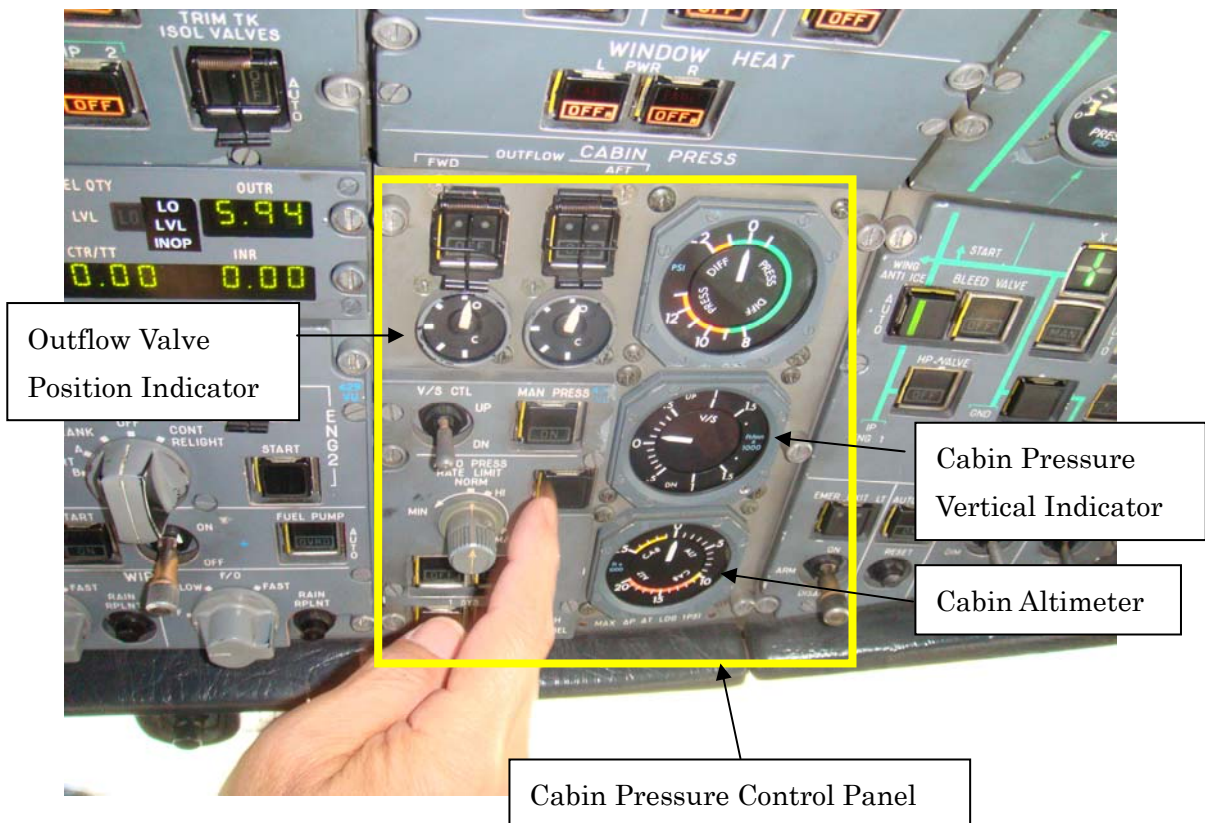

Photo 5 Air Bleed Control Panel

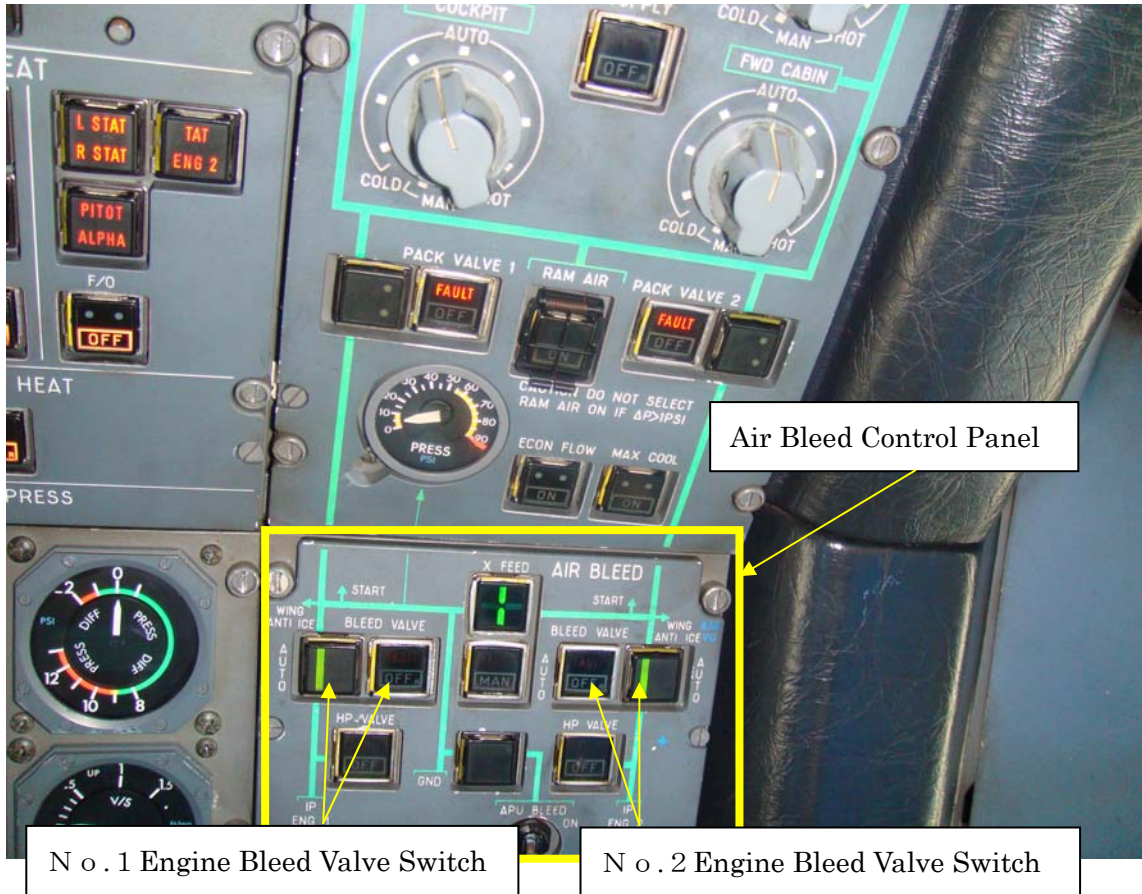

Photo 6 Cabin Oxygen Mask Drop

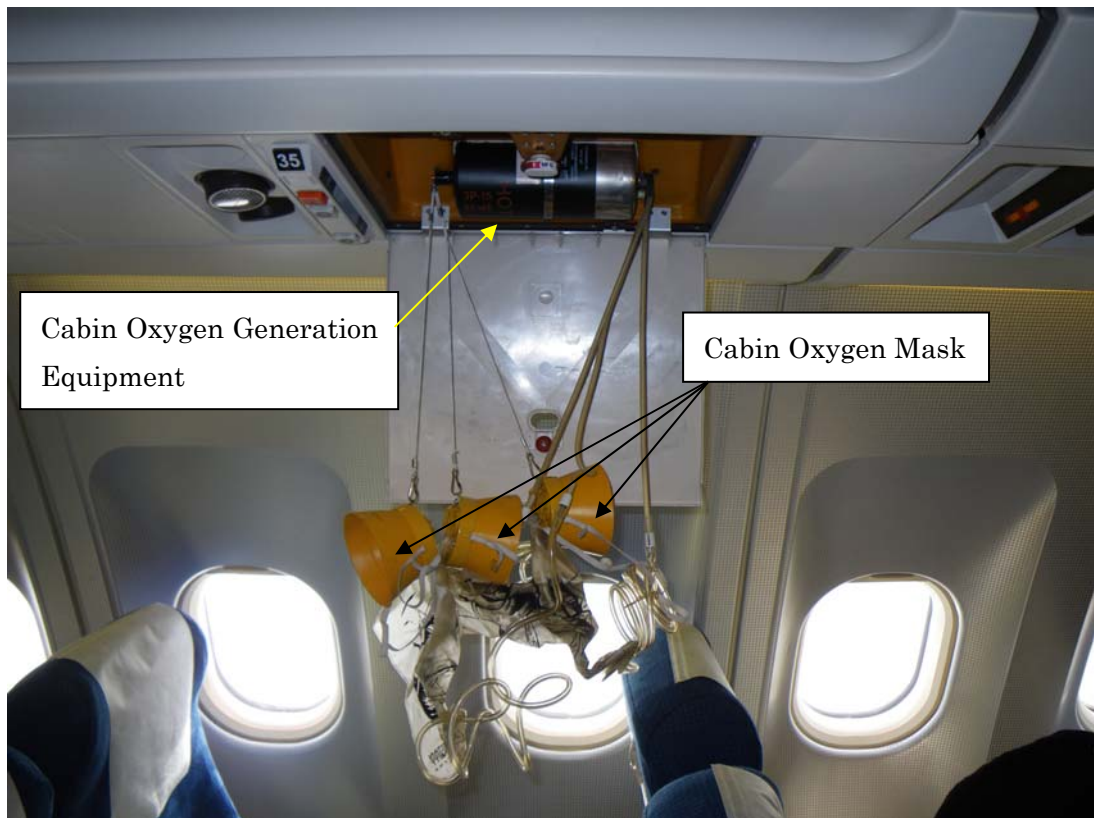

Photo 7 Cabin Oxygen Generation Equipment

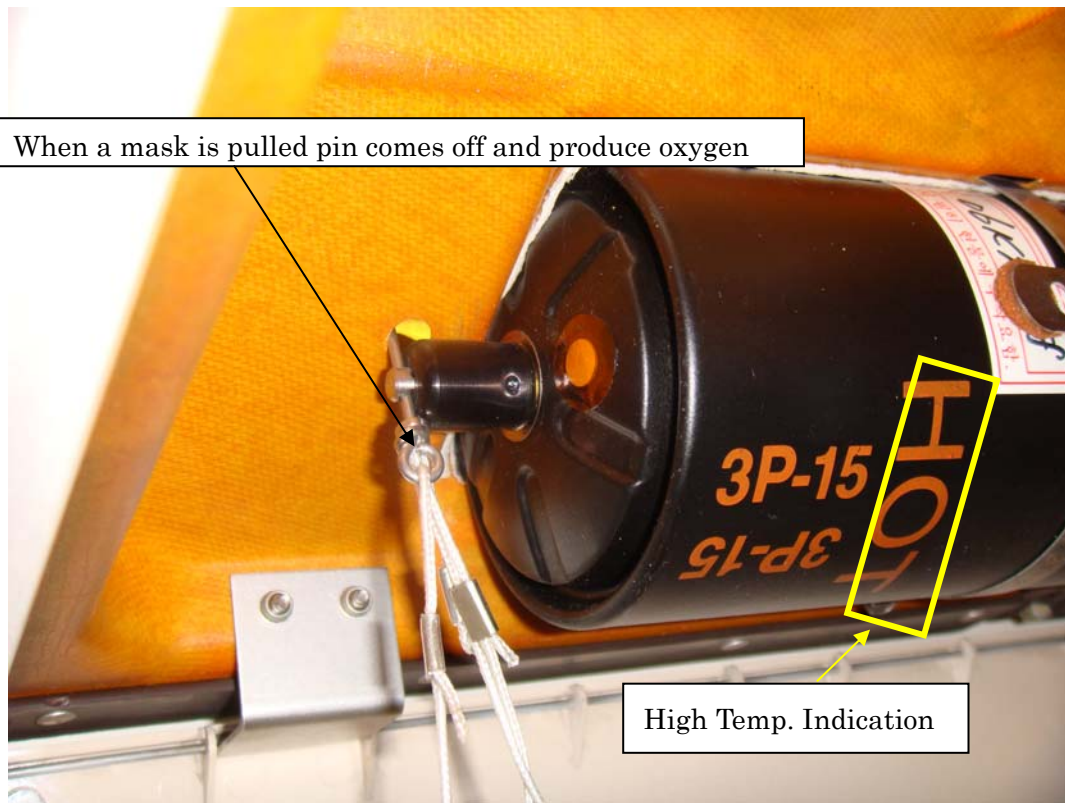
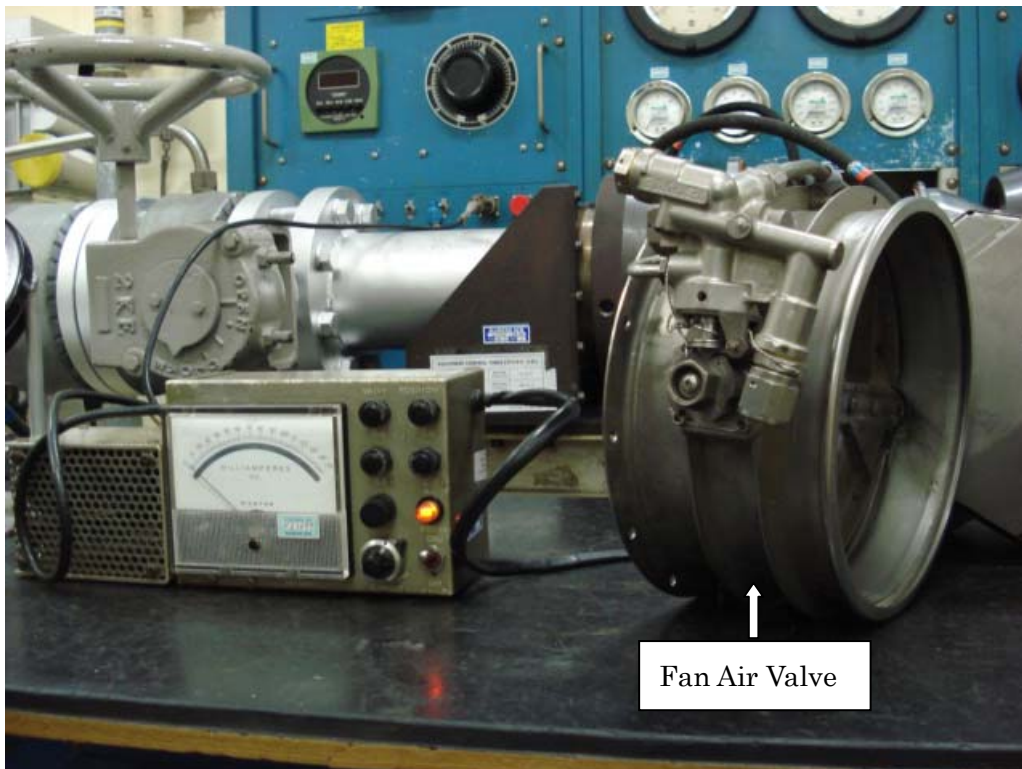

Photo 8 Fan Air Valve



## Attachment ATC Communication Records

10:38:06	KAL755	Korean Air 755, request descent. We have some pressurization failure.
14	Controller	Korean Air 755, stand by.
34	KAL755	MAY DAY, MAY DAY, MAY DAY, Korean Air 755, request descent due to 11,000. Emergency descent.
43	Controller	Korean Air 755, descend and maintain FL310. You wanna further descent ?
49	KAL755	310 unable. MAY DAY MAY DAY, Emergency descent, now descend 10,000, Korean Air 755.
54	Controller	Korean Air 755, roger, 10,000 understand.
10:39:11	KAL755	Korean Air 755, now descend 10,000, and passing heading 101.
19	Controller	Korean Air 755, descend 10,000 approved. Say again last.
10:40:22	Controller	Korean Air 755, ah...
10:40:29	KAL755	Korean Air 755, request heading 090.
34	Controller	Korean Air 755, 080 approved, maintain 10,000.
10:41:00	Controller	Korean Air 75...
23	Controller	Korean Air 755, request condition. What's wrong ?
10:42:30	Controller	Korean Air 755, request your nature of emergency. What's wrong ?
38	KAL755	Fukuoka Control, Korean Air 755, now descending 10,000. Emergency descent.
44	Controller	Roger, maintain 10,000. Emergency descent approved.
49	KAL755	Roger.
10:44:01	Controller	Korean Air 755, your position is 8nm South of MPE. Can you fly to ah Chubu-Centrair ? 10,000 ?
10	KAL755	Stand by, Korean Air 755.
13	Controller	Roger.
10:45:03	Controller	Korean Air 755, area QNH 2956.
7	KAL755	2956, Thank you.

# Explanation Diagram The Incident Occurrence Progress

