

モデル建物法における建物モデル

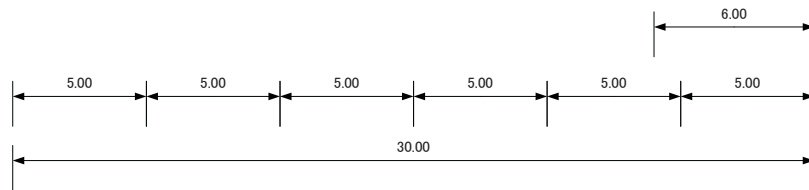

事務所 1F平面図

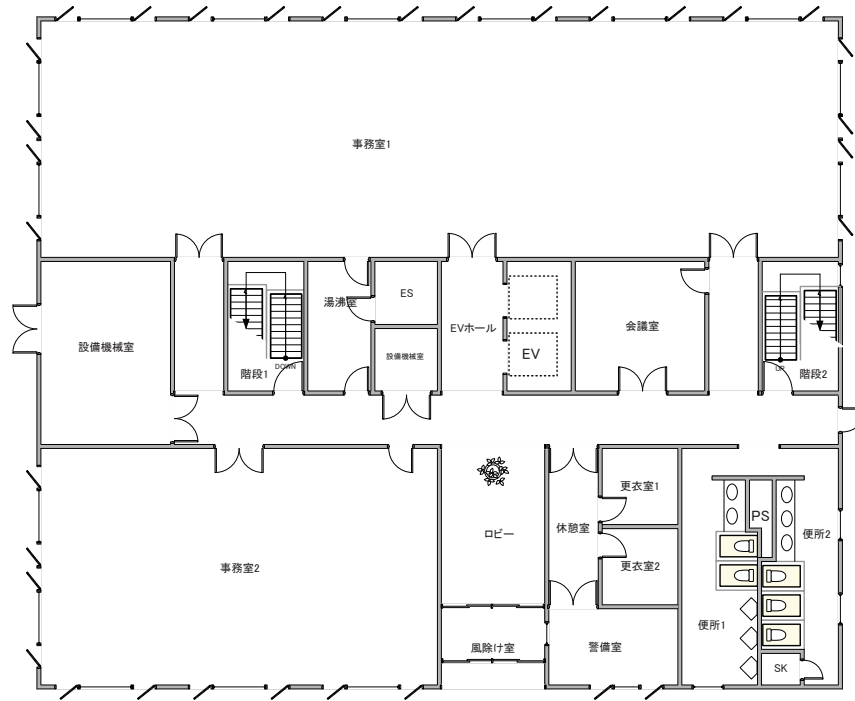
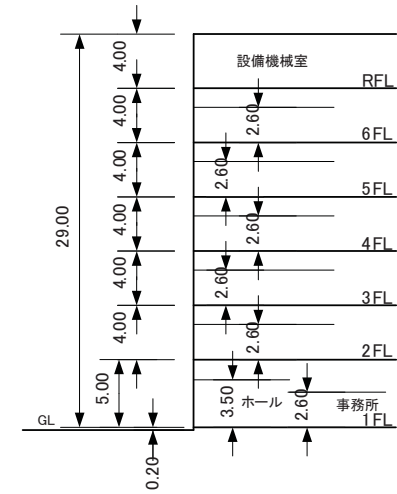
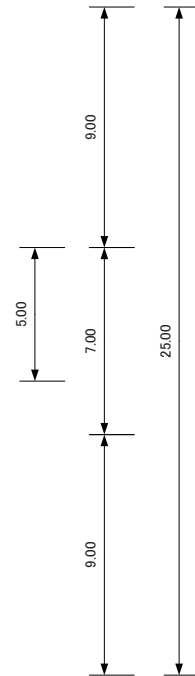

断面図

RF	50.00㎡
6F	750.00㎡
5F	750.00㎡
4F	750.00㎡
3F	750.00㎡
2F	750.00㎡
1F	746.00㎡

延べ床面積 4,546.00㎡

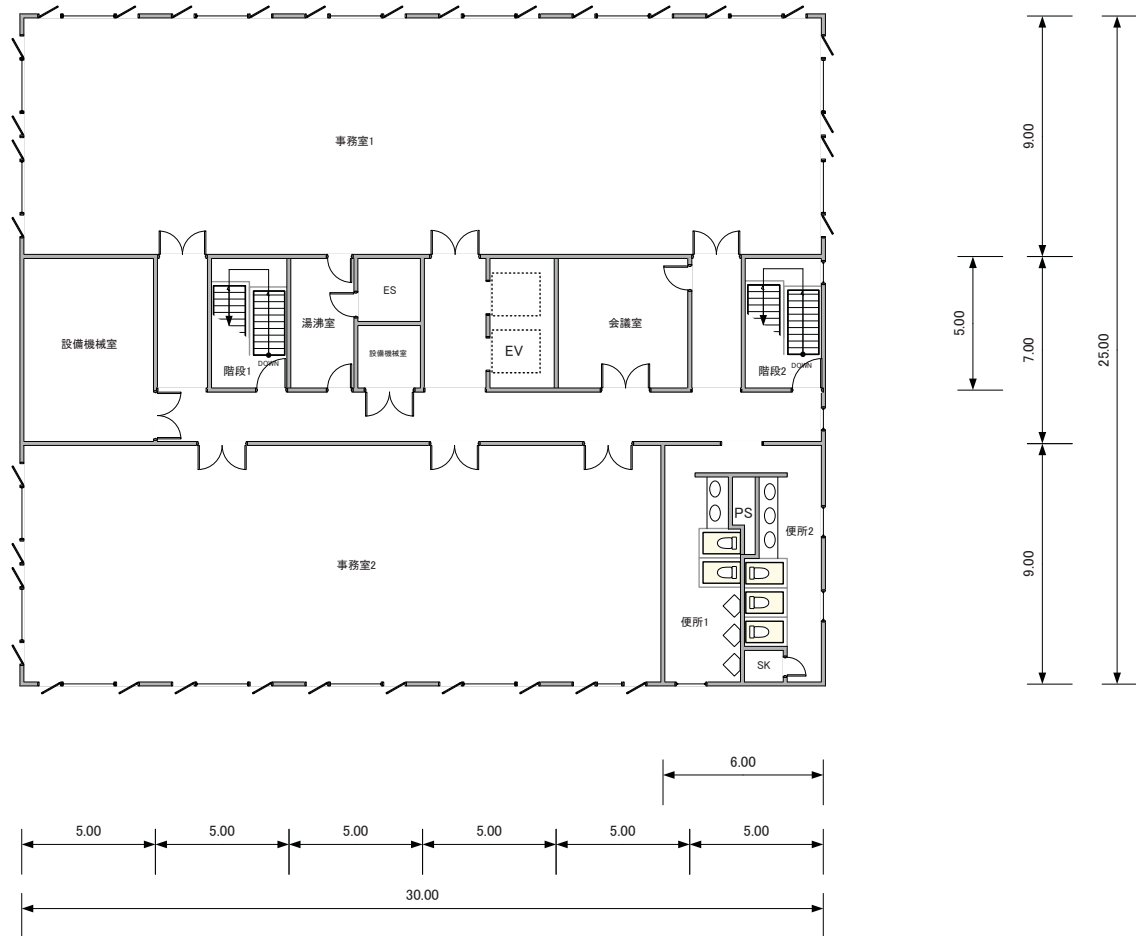

事務所 2F~6F平面図

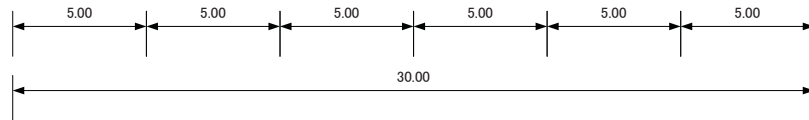
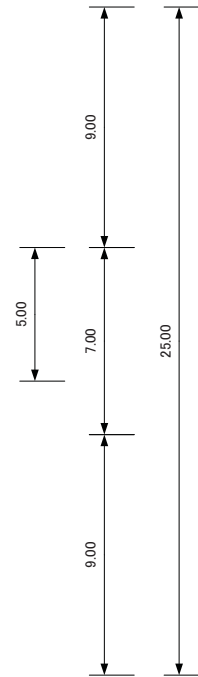
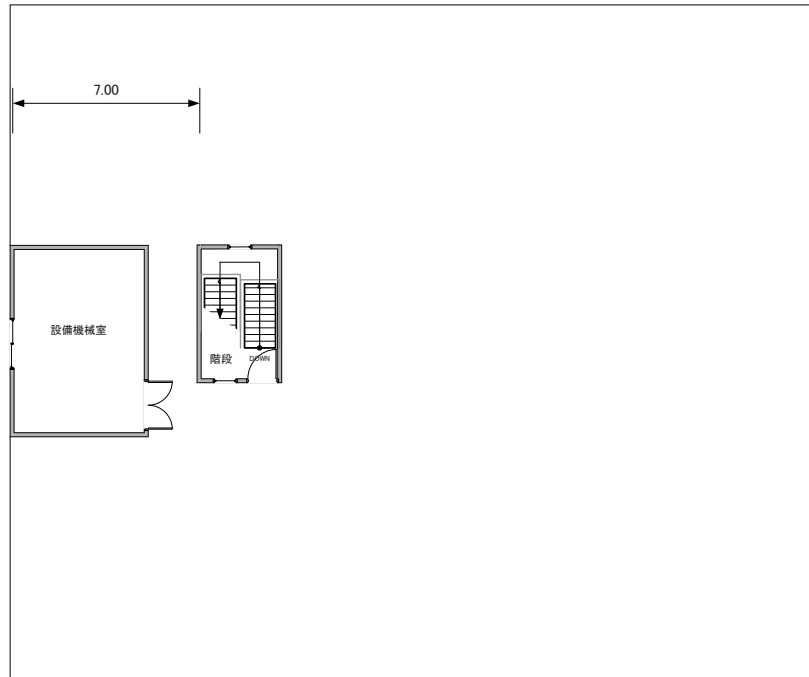

事務所 RF平面図

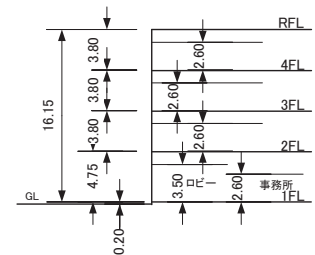
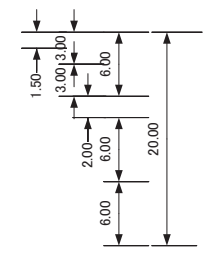
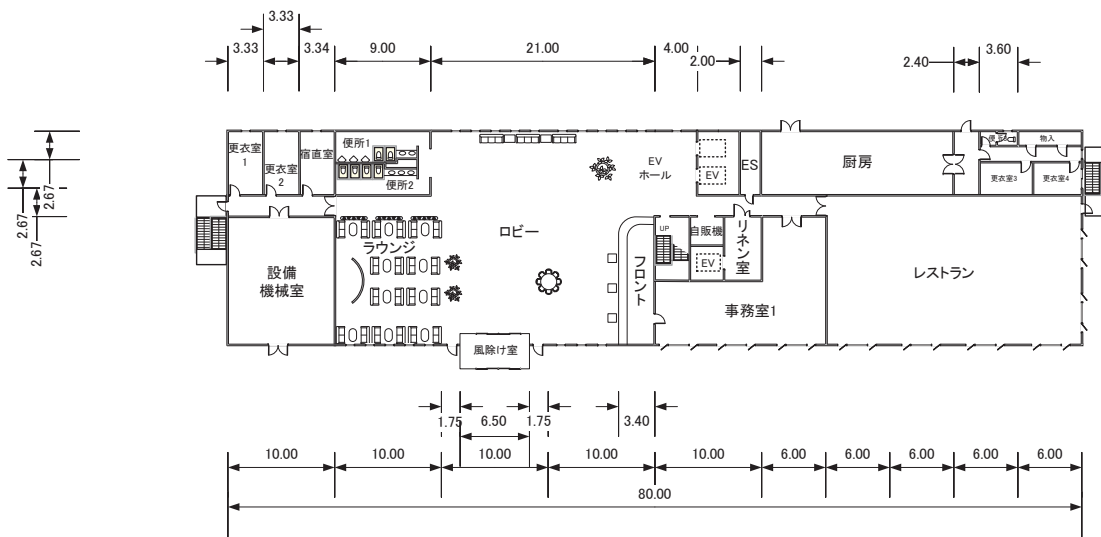

断面図

4F	1,120.00㎡
3F	1,120.00㎡
2F	1,120.00㎡
1F	1,600.00㎡
延べ床面積	4,960.00㎡

ホテル 1F平面図

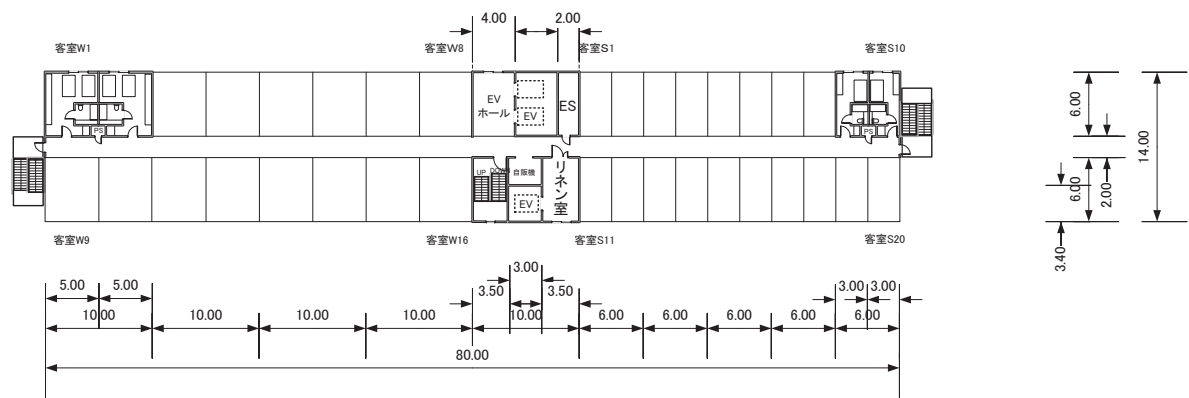

ホテル 2F~4F平面図

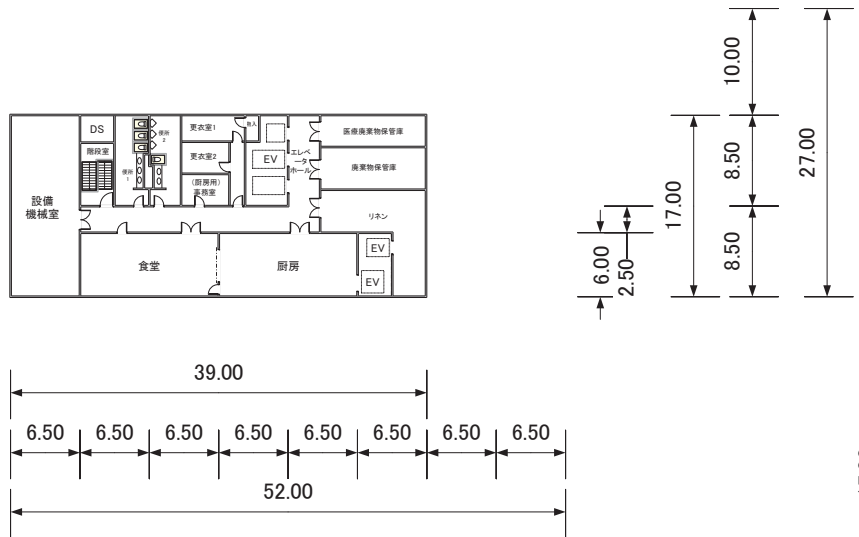

病院 B1F平面図

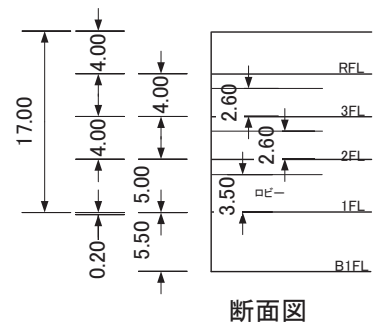

断面図

RF	80.75m ²
3F	1,404.00m ²
2F	1,404.00m ²
1F	1,397.00m ²
B1F	320.00m ²

延べ床面積 4,948.75m²

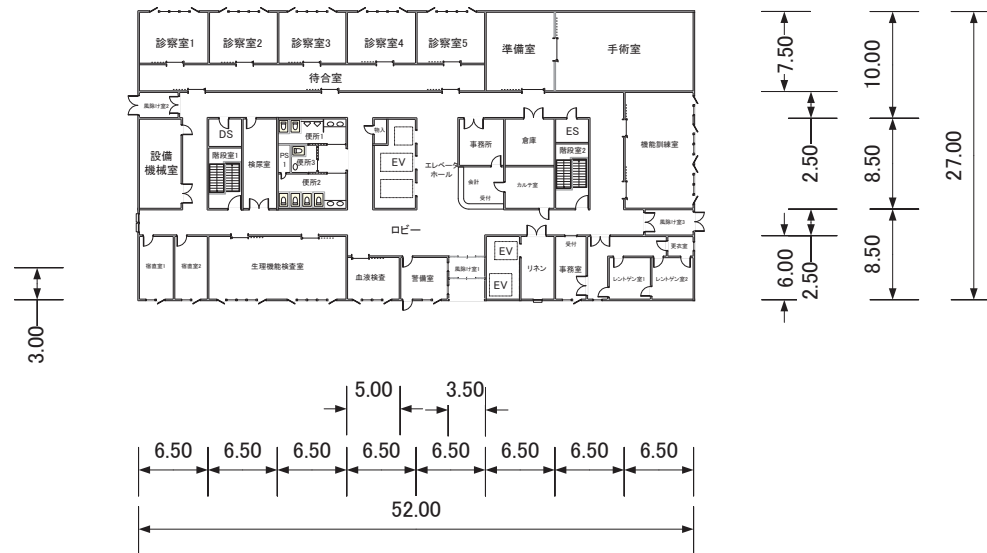

病院 1F平面図

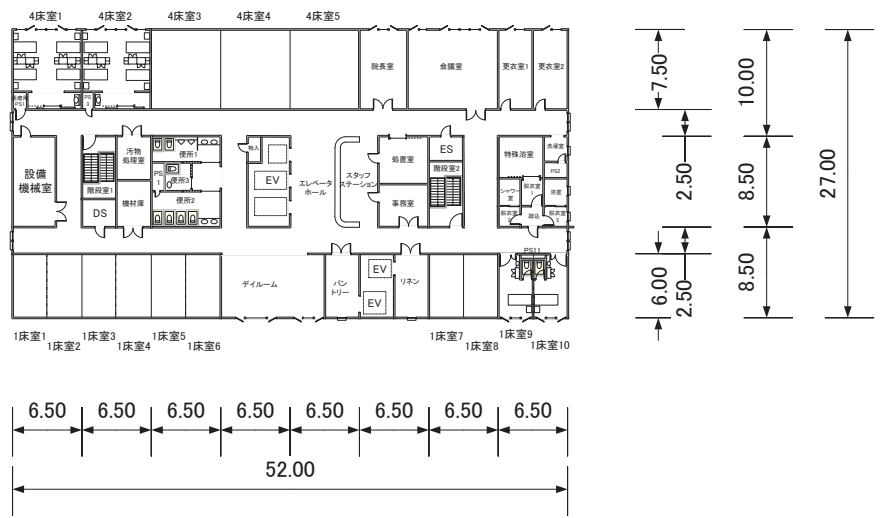

病院 3F平面図

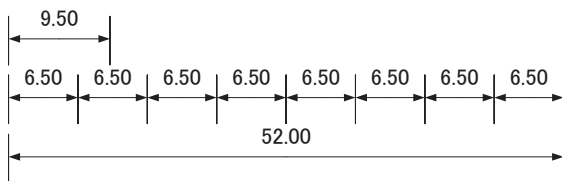
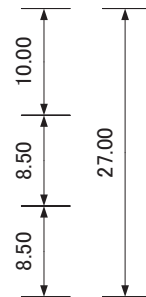
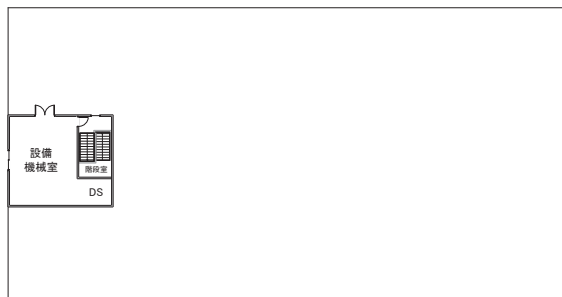

病院 RF平面图

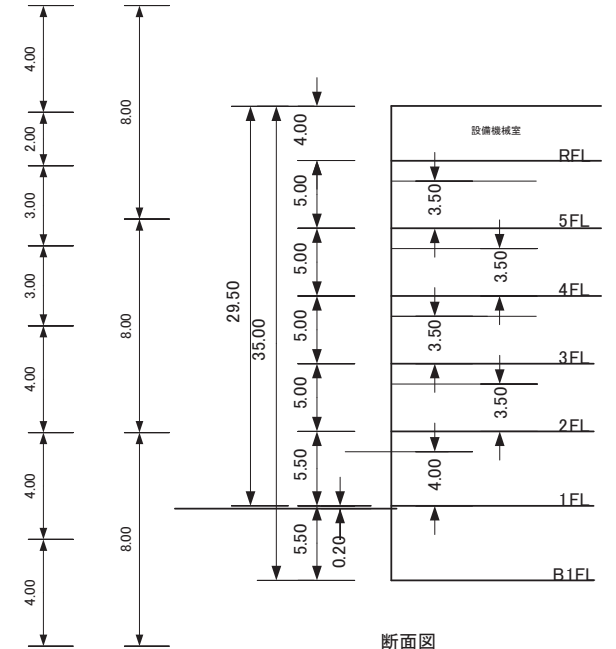
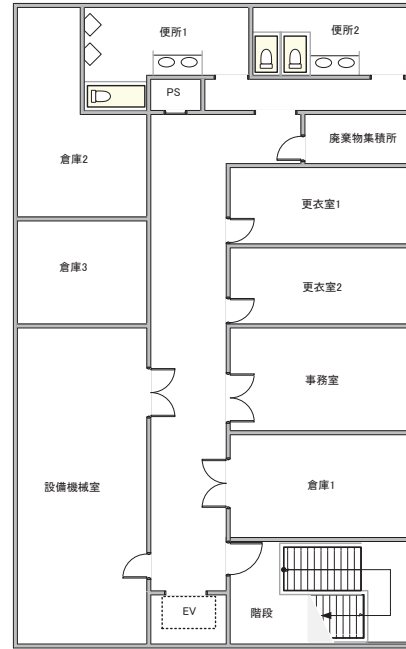

断面図

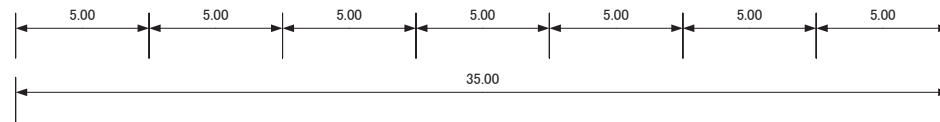

物販店舗 B1F平面図

RF	68.00 ^m
5F	840.00 ^m
4F	840.00 ^m
3F	840.00 ^m
2F	840.00 ^m
1F	840.00 ^m
B1F	360.00 ^m

延べ床面積 4,628.00^m

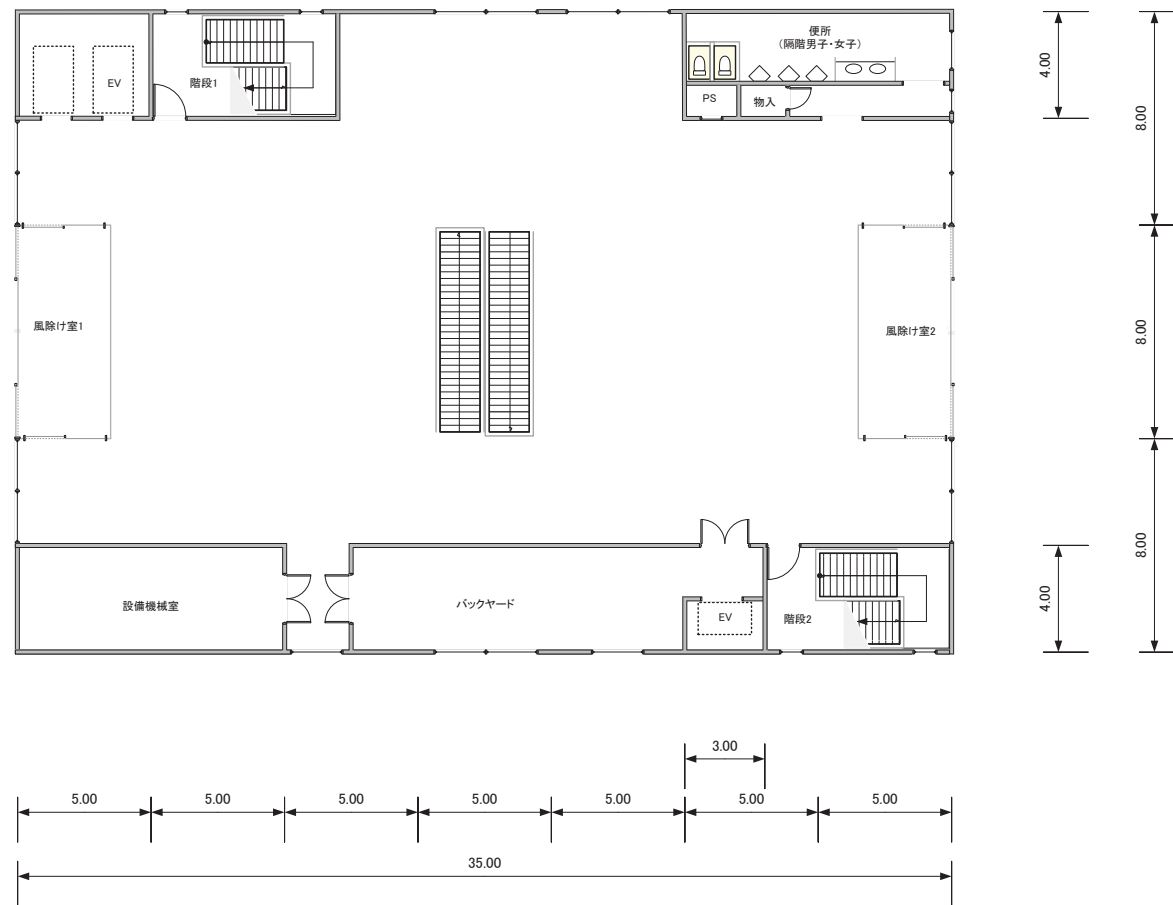

物販店舗 1F平面図

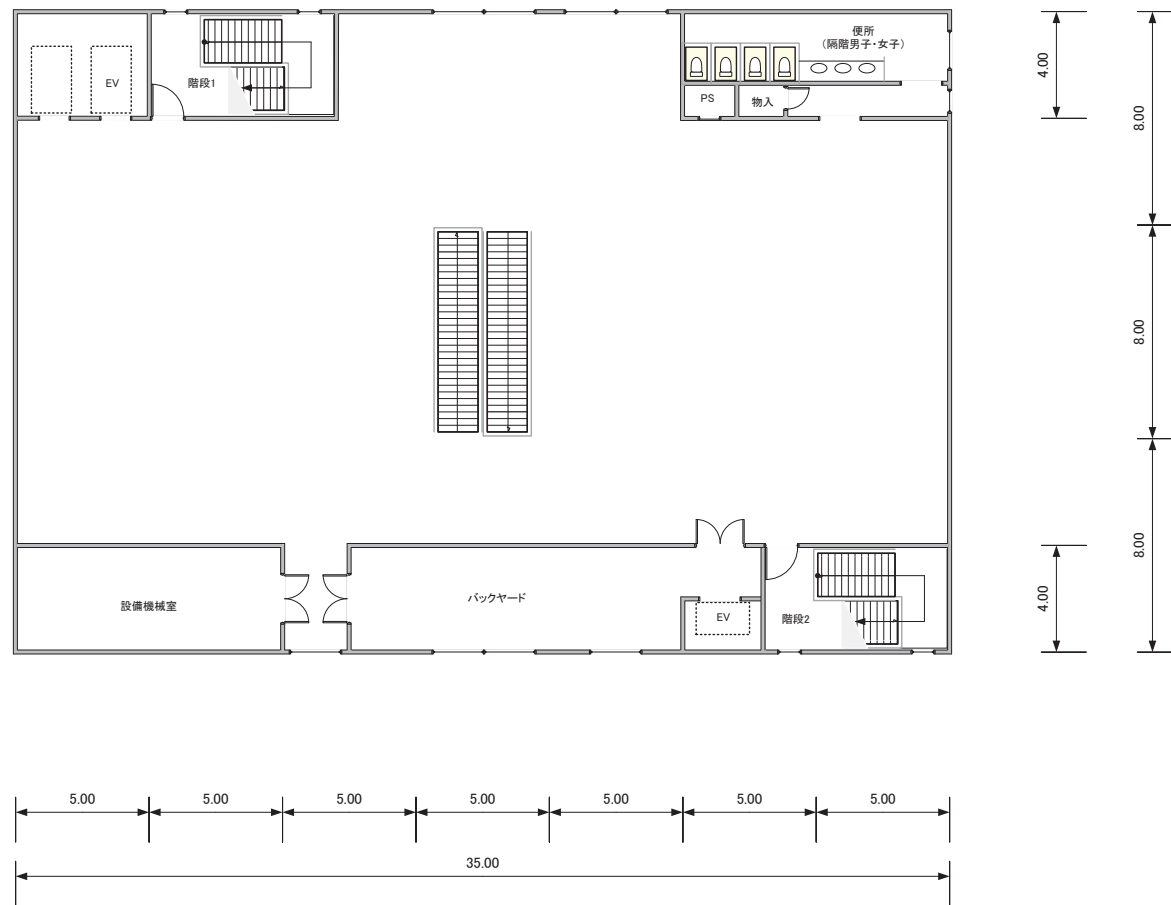

物販店舗 2F~5F平面図

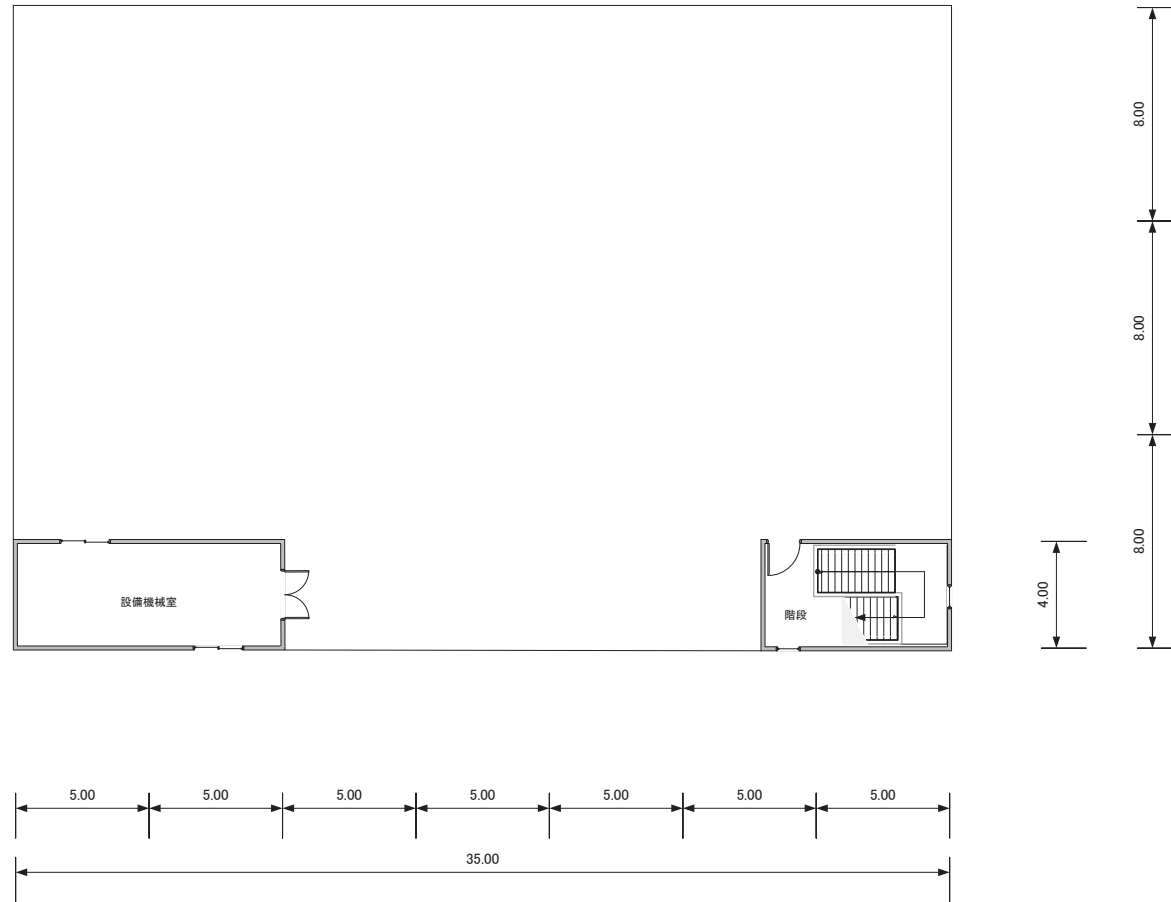

物販店舖 RF平面图

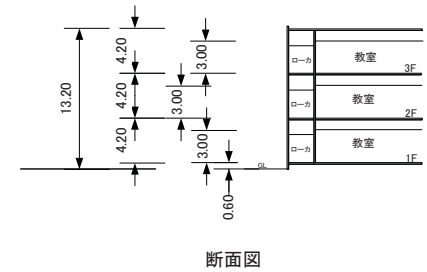
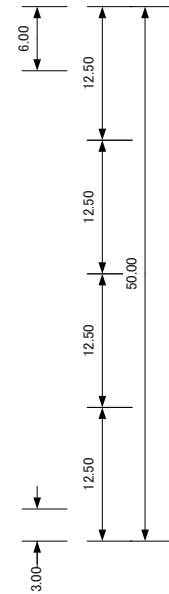
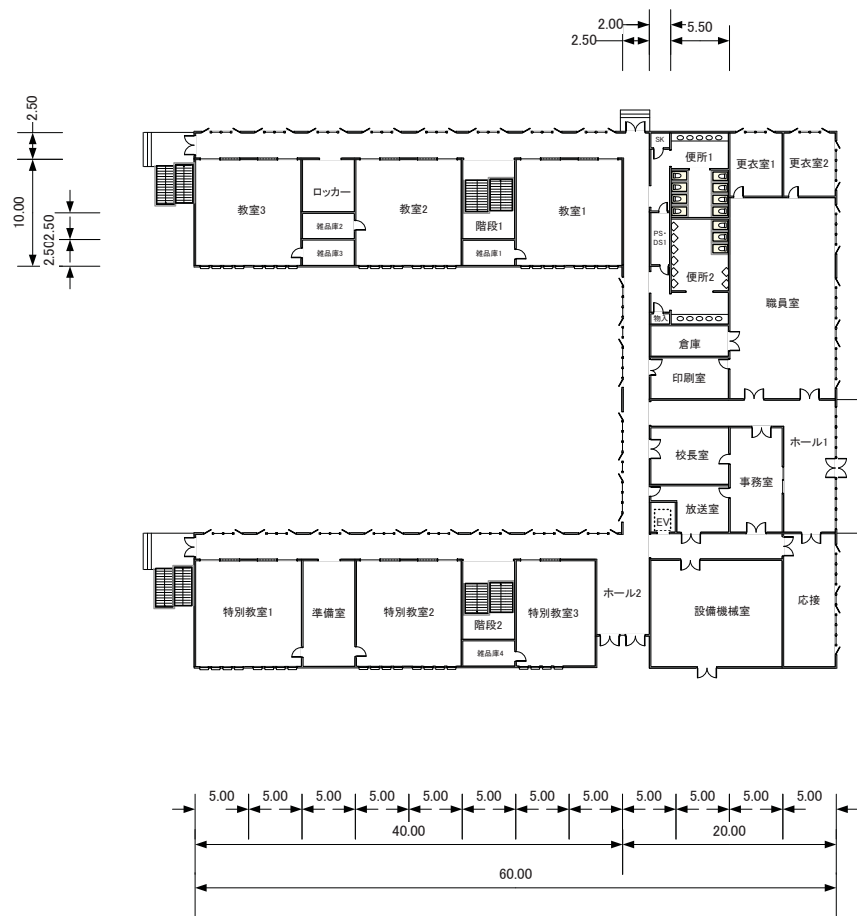

3F 1,000.00㎡
 2F 2,000.00㎡
 1F 1,985.00㎡

延べ床面積 4,985.00㎡

学校 1F平面図

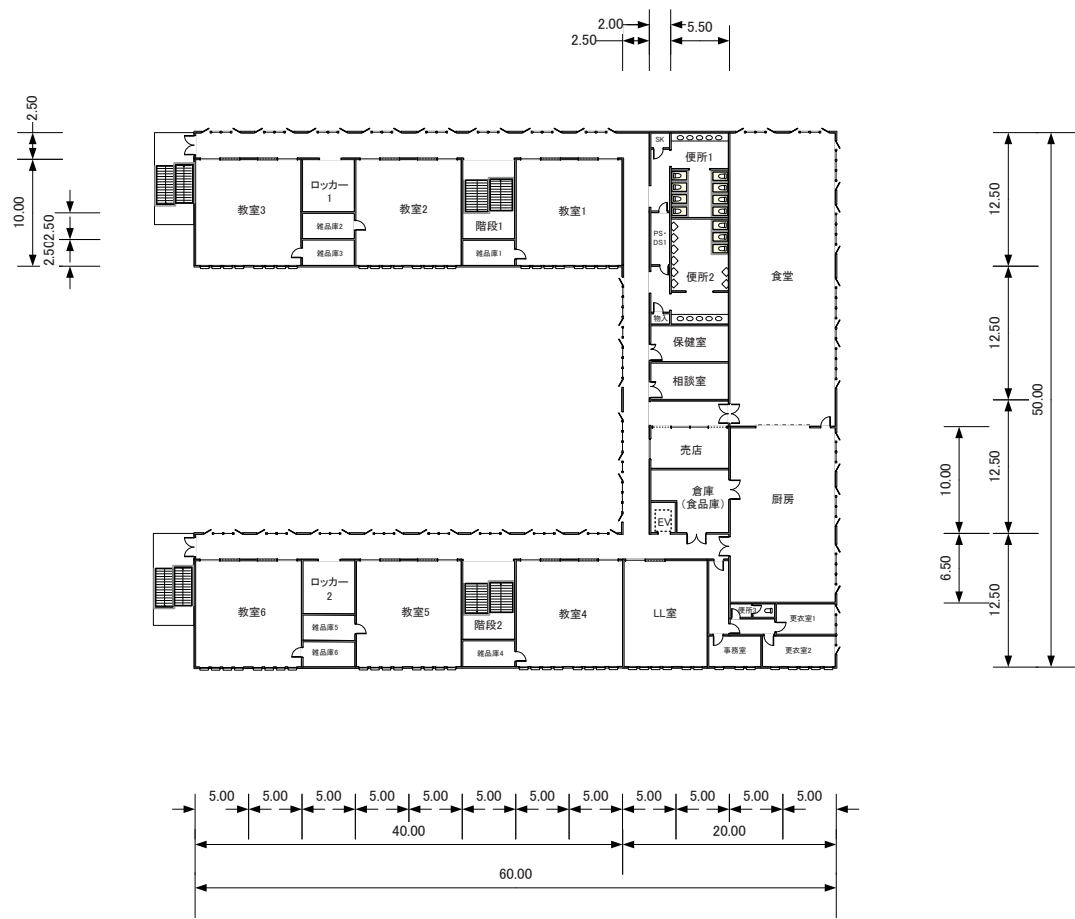

学校 2F平面図

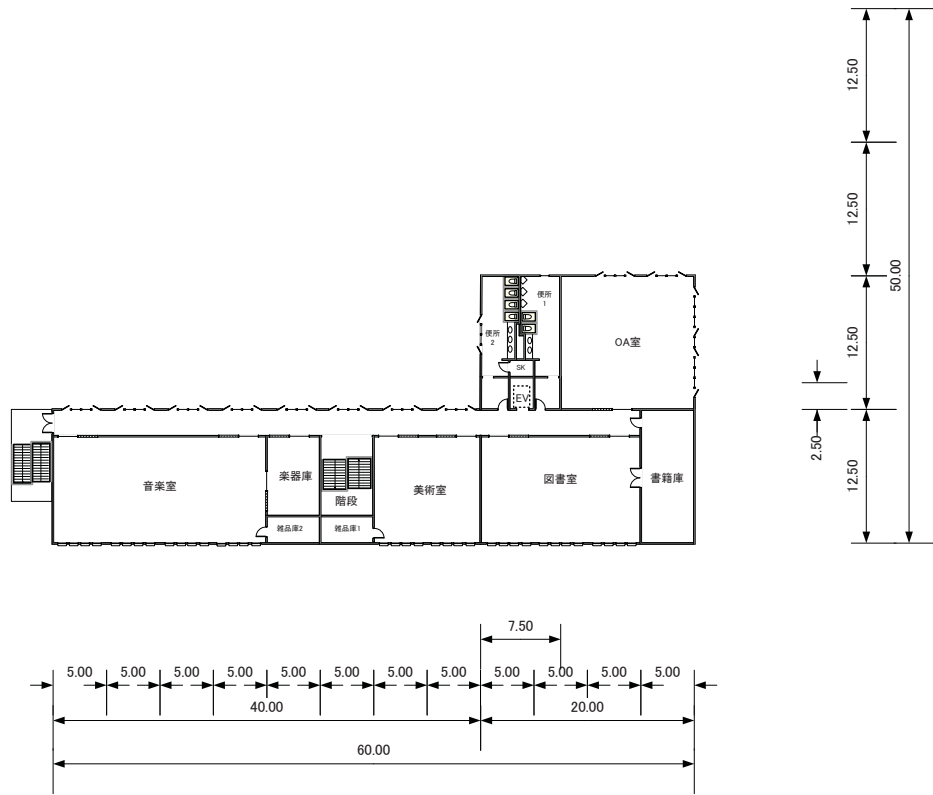

学校 3F平面图

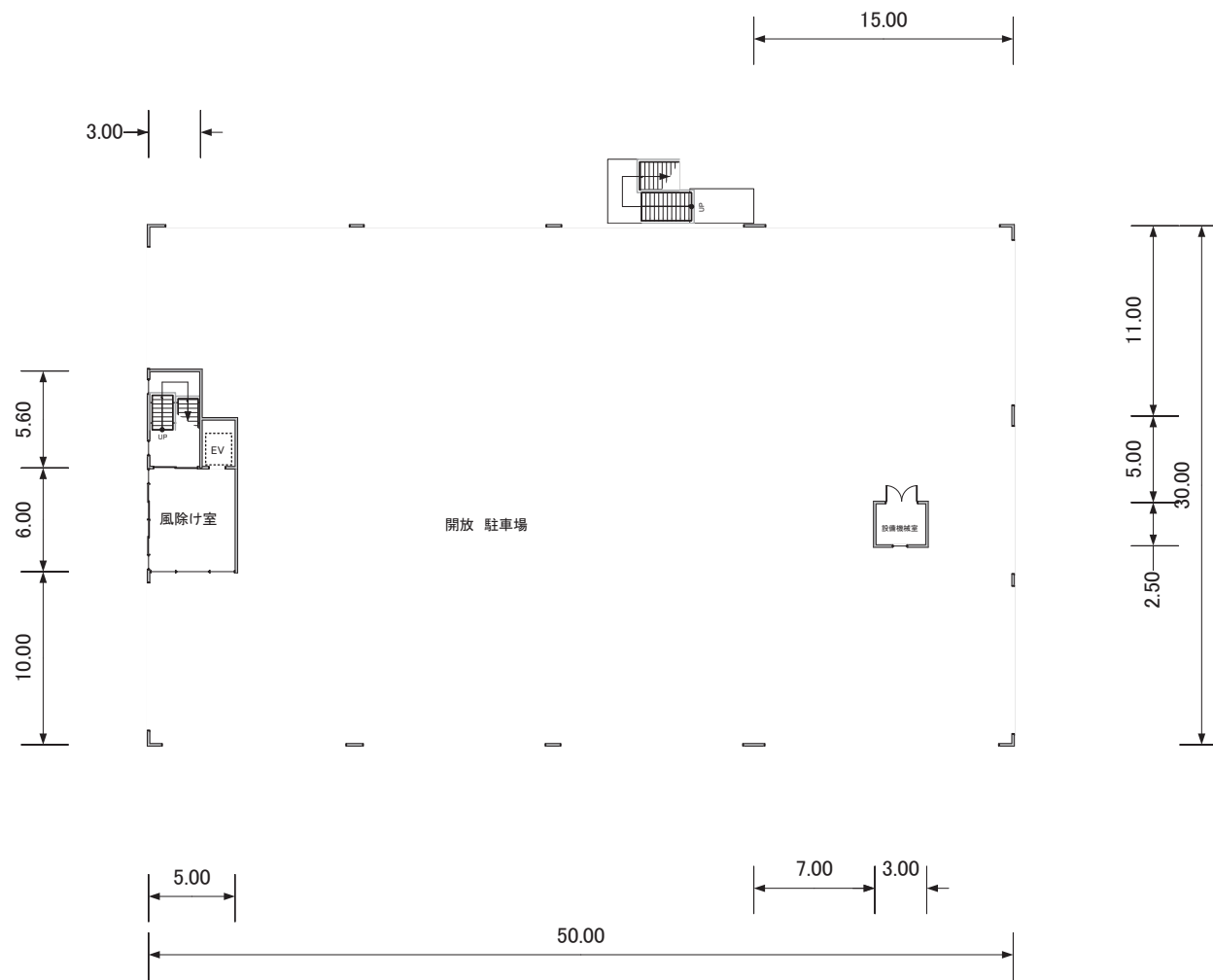

飲食店 1F平面図

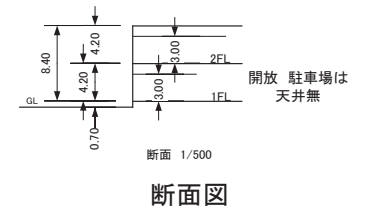

断面図

2F 1,500.00^m²
 1F 59.90^m²
 延べ床面積
 1,559.90^m²
 255席

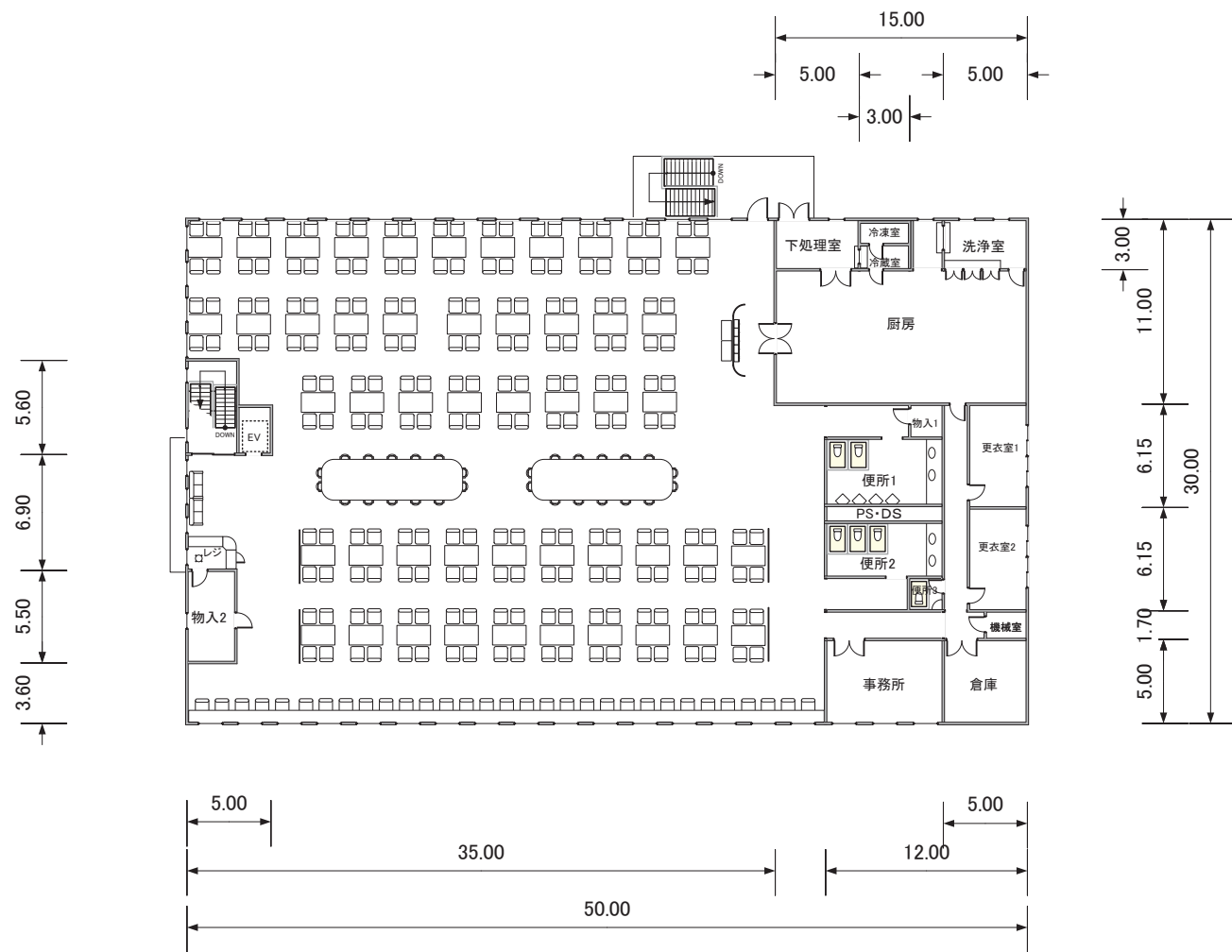

飲食店 2F平面図